

1. Description

BLG40T65FUK is obtained by advanced Trench Field Stop (T-FS) technology which is characteristic with low $V_{CE(sat)}$, optimized switching performance and low gate charge Q_g . The IGBT is suitable device for welding, UPS, and high switching frequency applications.

KEY CHARACTERISTICS

Parameter	Value	Unit
V_{CES}	650	V
I_c	40	A
$V_{CE(sat).typ}$	1.55	V

FEATURES

- Fast Switching
- LOW $V_{CE(sat)}$
- Positive temperature coefficient
- Fast recovery anti-parallel diode
- RoHS product

APPLICATIONS

- Welding converters
- UPS
- Boost Chopper
- Air condition

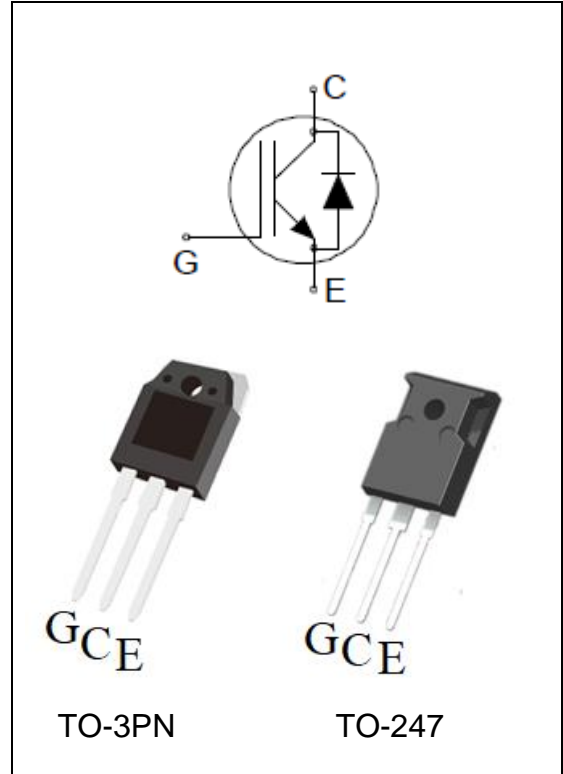

ORDERING INFORMATION

Device Marking	Ordering Codes	Package	Product Code	Packing
40T65FUK	BLG40T65FUK-W	TO-3PN	G40T65FUK	Tube
	BLG40T65FUK-F	TO-247	G40T65FUK	Tube

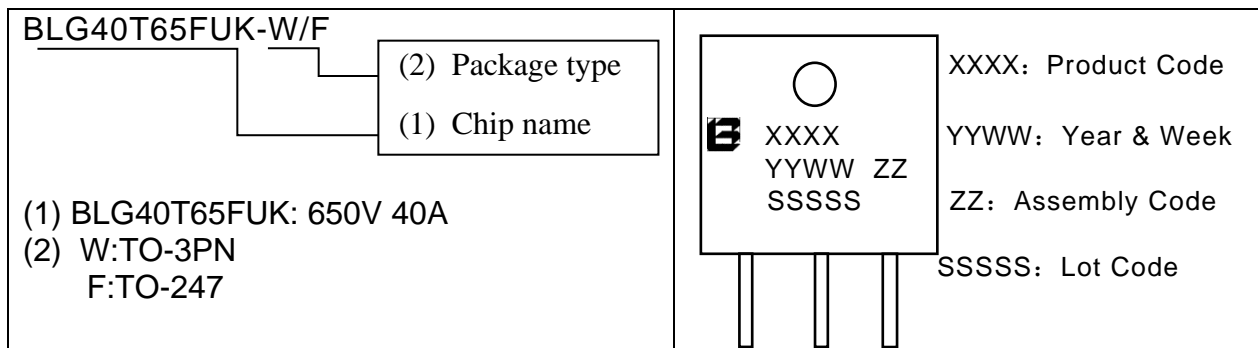

2. ABSOLUTE RATINGS

Symbol	Parameter	Values	Units
V_{CES}	Collector-Emitter Voltage	650	V
I_C	Collector Current @ $T_C=25^{\circ}C$	80	A
	Collector Current @ $T_C=100^{\circ}C$	40	A
I_{CM}	Pulsed Collector Current, tp limited by T_{Jmax}	160	A
I_F	Diode Continuous Forward Current @ $T_C=25^{\circ}C$	40	A
	Diode Continuous Forward Current @ $T_C=100^{\circ}C$	20	A
I_{FM}	Diode Maximum Forward Current, limited by T_{Jmax}	80	A
V_{GES}	Gate-Emitter Voltage	± 30	V
t_{SC}	Short circuit withstand time $V_{GE}=15V$, $V_{CC}\leq 400V$, Allowed number of short circuits<1000, Times between short circuits: $\geq 1.0s$, $T_J\leq 175^{\circ}C$	3.0	μs
P_D	Power Dissipation @ $T_C=25^{\circ}C$	300	W
T_{Jmax} , T_{stg}	Operating Junction and Storage Temperature Range	175, -55 to 175	$^{\circ}C$
T_L	Maximum Temperature for Soldering	260	$^{\circ}C$

3. Thermal characteristics

Symbol	Parameter	Values	Units
$R_{\theta JC}$	Junction-to-Case (IGBT)	0.5	$^{\circ}C/W$
$R_{\theta JC}$	Junction-to-Case (Diode)	0.8	$^{\circ}C/W$
$R_{\theta JA}$	Junction-to-Ambient	40	$^{\circ}C/W$

4. Electrical Characteristics

at $T_C = 25^{\circ}C$, unless otherwise specified

Static Characteristics

Symbol	Parameter	Test Conditions	Values			Units
			Min.	Typ.	Max.	
V_{CES}	Collector-Emitter Breakdown Voltage	$V_{GE} = 0V$, $I_C = 250\mu A$	650	--	--	V
$V_{CE(sat)}$	Collector-Emitter Saturation Voltage	$V_{GE} = 15V, I_C = 40A$ $T_J=25^{\circ}C$	--	1.55	1.95	V
		$T_J=125^{\circ}C$	--	1.80	--	
		$T_J=175^{\circ}C$	--	1.90	--	
$V_{GE(TH)}$	Gate Threshold Voltage	$V_{CE} = V_{GE}, I_C = 1mA$	4.7	5.5	6.2	V

V _F	Diode Forward Voltage	I _F =20A T _J =25°C	--	2.20	2.8	V
		T _J =125°C	--	1.80	--	
		T _J =175°C	--	1.65	--	
I _{CES}	Collector-Emitter Leakage Current	V _{CE} = 650V, V _{GE} = 0V	--	--	25	μA
I _{GES(F)}	Gate-Emitter Forward Leakage Current	V _{GE} = +30V	--	--	200	nA
I _{GES(R)}	Gate-Emitter Reverse Leakage Current	V _{GE} = -30V	--	--	-200	nA
Pulse width $t_p \leq 300\mu s$, $\delta \leq 2\%$						

Dynamic Characteristics

Symbol	Parameter	Test Conditions	Values			Units
			Min.	Typ.	Max.	
C _{iss}	Input Capacitance	V _{GE} =0V V _{CE} =25V f =1.0MHz	--	2225	--	pF
C _{oss}	Output Capacitance		--	90	--	
C _{rss}	Reverse Transfer Capacitance		--	27	--	
Q _G	Gate charge	V _{CC} =520V I _{CE} =20A V _{GE} =15V	--	110	--	nC
Q _{GE}	Gate-emitter charge		--	52	--	
Q _{GC}	Gate-collector charge		--	23	--	
I _{C(SC)}	Short circuit collector current Max.1000 short circuits, Times between short circuits: ≥ 1.0s	V _{GE} =15.0V, V _{CC} ≤400V, t _{sc} ≤3us, T _J ≤175°C		320		A

IGBT Switching Characteristics, at T_J=25°C

Symbol	Parameter	Test Conditions	Values			Units
			Min.	Typ.	Max.	
t _{d(on)}	Turn-on Delay Time	I _C =40A V _{CE} = 400V V _{GE} = 15V R _G =5Ω T _J =25°C Inductive Load	--	19	--	ns
t _r	Rise Time		--	35	--	
t _{d(off)}	Turn-Off Delay Time		--	90	--	
t _f	Fall Time		--	26	--	
E _{on}	Turn-On Switching Loss		--	0.60	--	mJ
E _{off}	Turn-Off Switching Loss		--	0.38	--	
E _{ts}	Total Switching Loss		--	0.98	--	

IGBT Switching Characteristics, at $T_J=175^\circ\text{C}$

Symbol	Parameter	Test Conditions	Values			Units
			Min.	Typ.	Max.	
$t_{d(on)}$	Turn-on Delay Time	$I_C = 40\text{A}$ $V_{CE} = 400\text{V}$ $V_{GE} = 15\text{V}$ $R_G = 5\Omega$ $T_J = 175^\circ\text{C}$ Inductive Load	--	17	--	ns
t_r	Rise Time		--	32	--	
$t_{d(off)}$	Turn-Off Delay Time		--	142	--	
t_f	Fall Time		--	36	--	
E_{on}	Turn-On Switching Loss		--	0.8	--	mJ
E_{off}	Turn-Off Switching Loss		--	0.65	--	
E_{ts}	Total Switching Loss		--	1.45	--	

Diode Characteristics, at $T_J=25^\circ\text{C}$

Symbol	Parameter	Test Conditions	Values			Units
			Min.	Typ.	Max.	
T_{rr}	Reverse Recovery Time	$I_F = 20\text{A}$, $di/dt = 200\text{A}/\mu\text{s}$, $T_J = 25^\circ\text{C}$	--	97	--	ns
Q_{rr}	Reverse Recovery Charge		--	109	--	nC
I_{rrm}	Reverse Recovery Current		--	1.8	--	A
T_{rr}	Reverse Recovery Time	$I_F = 40\text{A}$, $di/dt = 200\text{A}/\mu\text{s}$, $T_J = 25^\circ\text{C}$	--	127	--	ns
Q_{rr}	Reverse Recovery Charge		--	326	--	nC
I_{rrm}	Reverse Recovery Current		--	4.8	--	A

Diode Characteristics, at $T_J=175^\circ\text{C}$

Symbol	Parameter	Test Conditions	Values			Units
			Min.	Typ.	Max.	
T_{rr}	Reverse Recovery Time	$I_F = 20\text{A}$, $di/dt = 200\text{A}/\mu\text{s}$, $T_J = 175^\circ\text{C}$	--	147	--	ns
Q_{rr}	Reverse Recovery Charge		--	742	--	nC
I_{rrm}	Reverse Recovery Current		--	7.8	--	A
T_{rr}	Reverse Recovery Time	$I_F = 40\text{A}$, $di/dt = 200\text{A}/\mu\text{s}$, $T_J = 175^\circ\text{C}$	--	158	--	ns
Q_{rr}	Reverse Recovery Charge		--	870	--	nC
I_{rrm}	Reverse Recovery Current		--	9	--	A

5. Characteristics Curves

Figure 1. Forward Bias Safe Operating Area for TO3PN/TO247

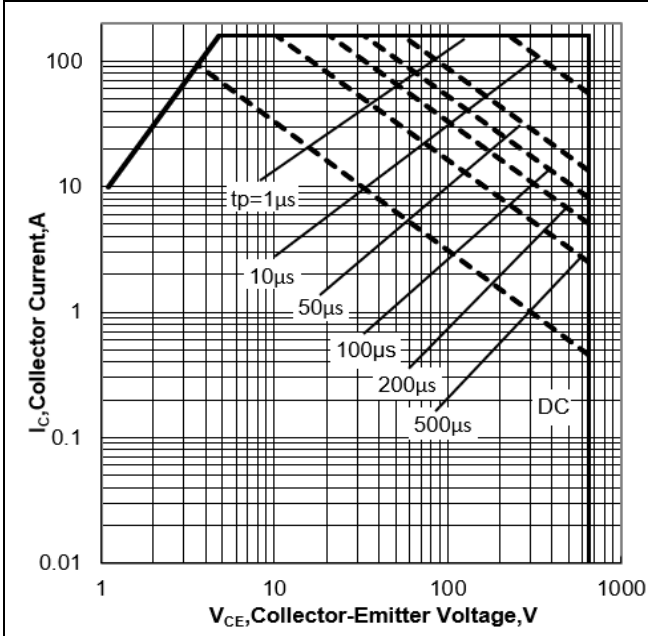

Figure 2. Power Dissipation vs Case Temperature for TO3PN/TO247

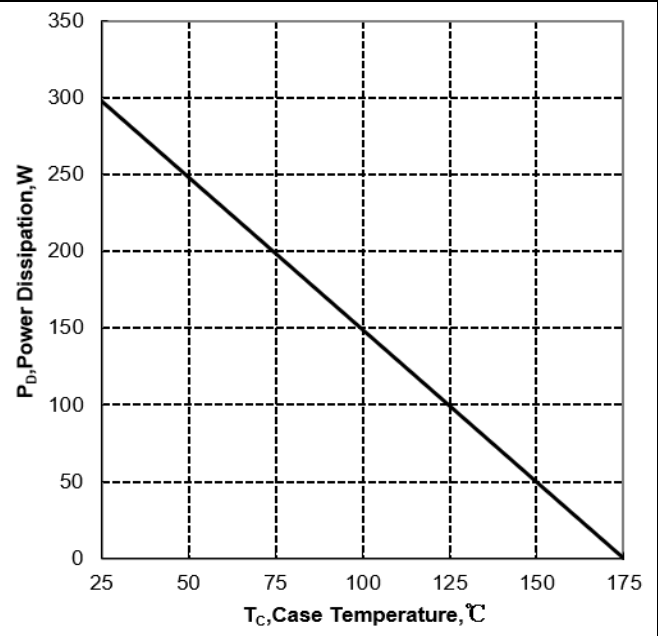

Figure 3. Collector Current vs Case Temperature

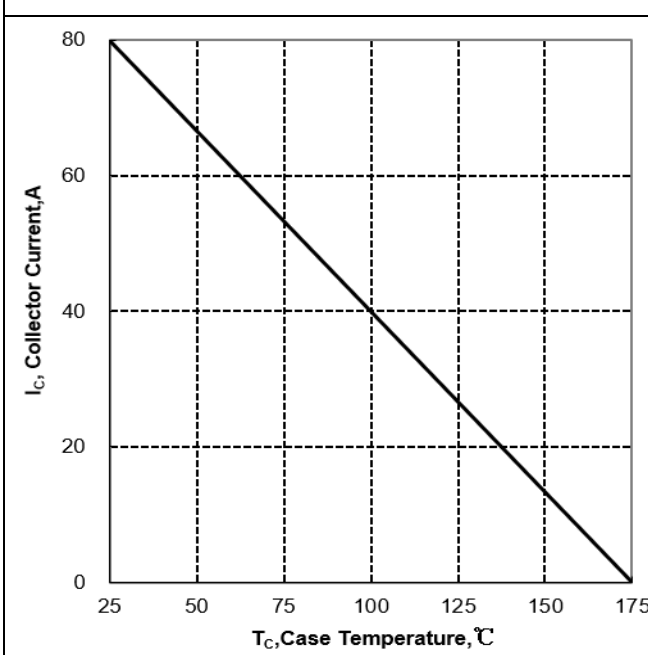

Figure 4. Typical Transfer Characteristics

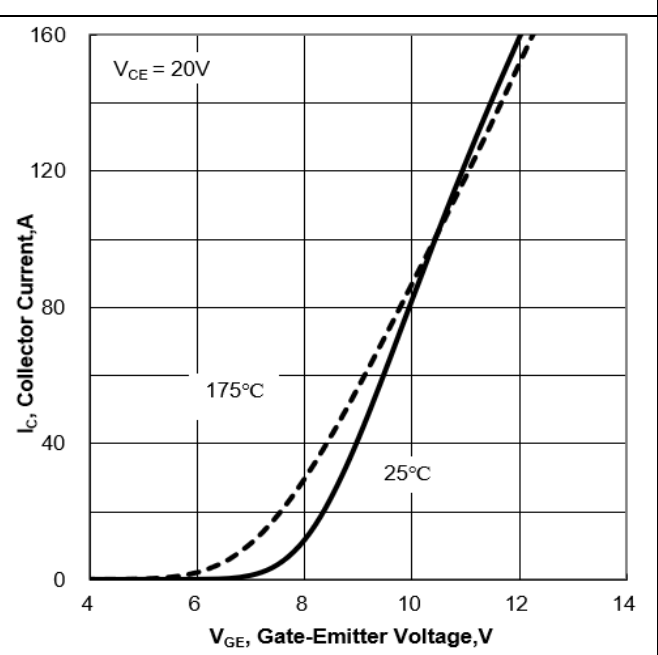

Figure 5. Typical Output Characteristics (T_J=25°C)

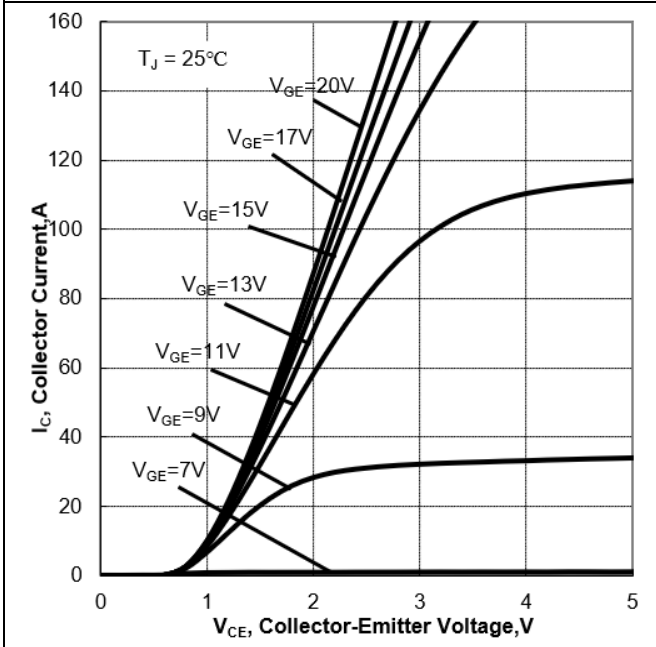

Figure 6. Typical Output Characteristics (T_J=175°C)

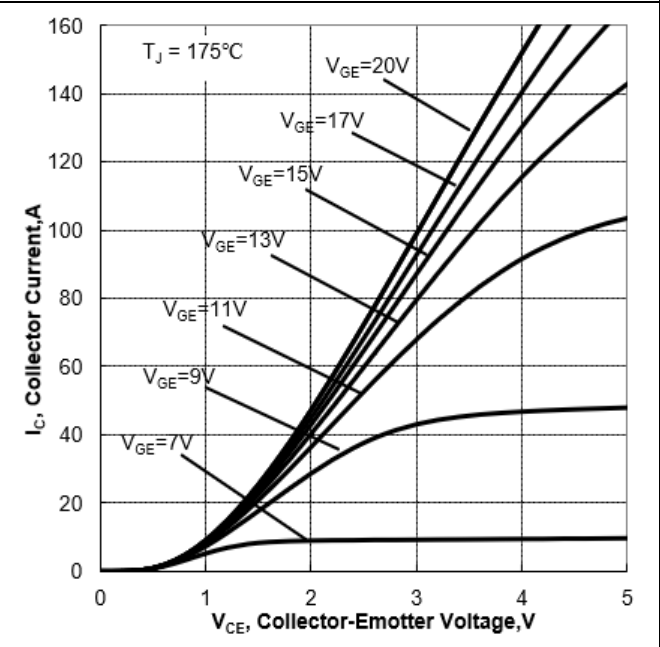

Figure 7. Typical Collector-Emitter Saturation Voltage vs Junction Temperature

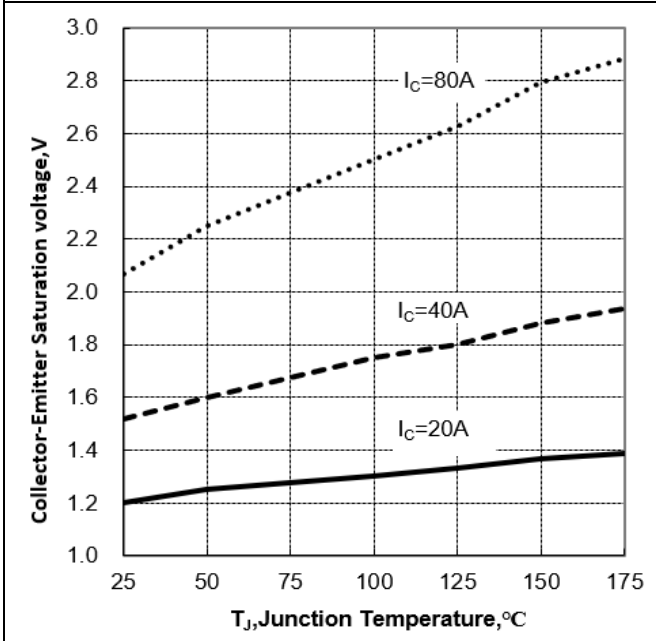
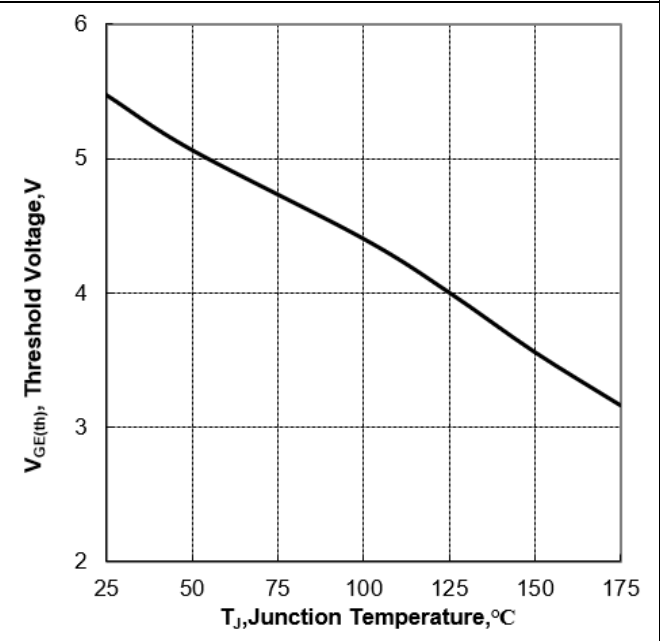

Figure 8. Typical Gate-Emitter Threshold Voltage vs Junction Temperature



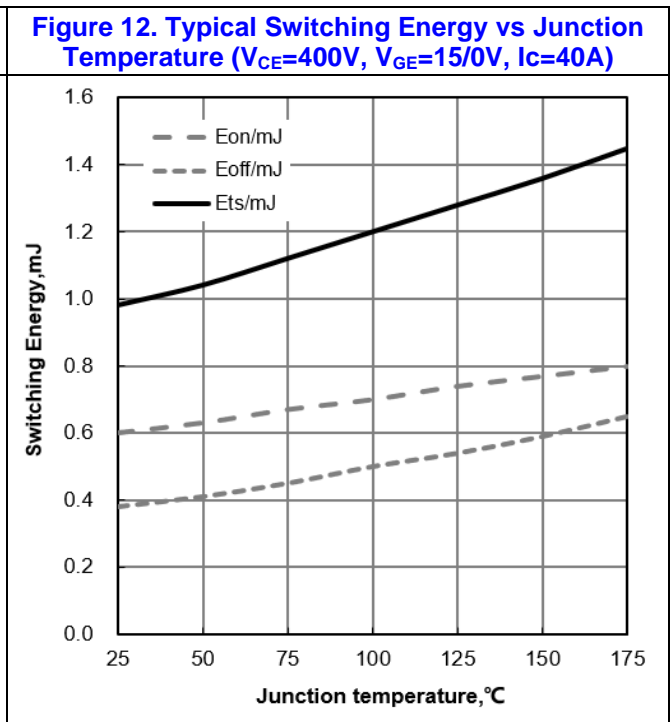
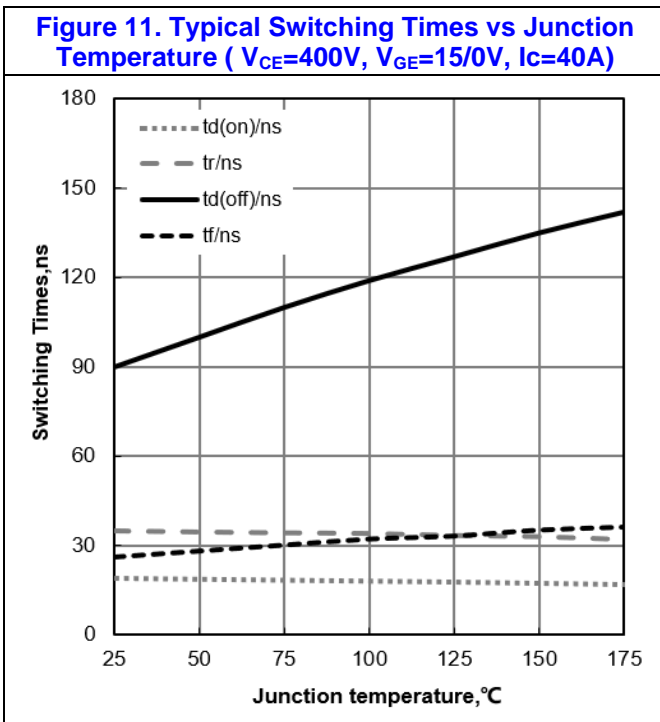
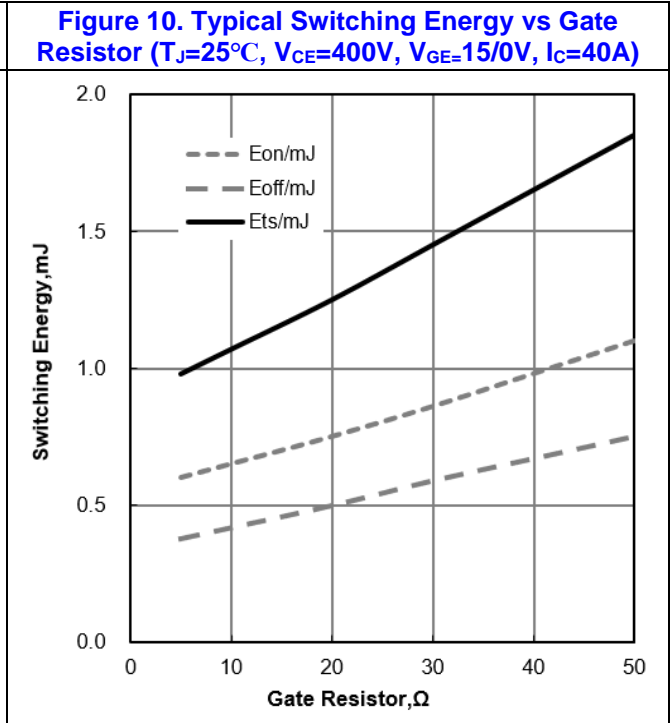
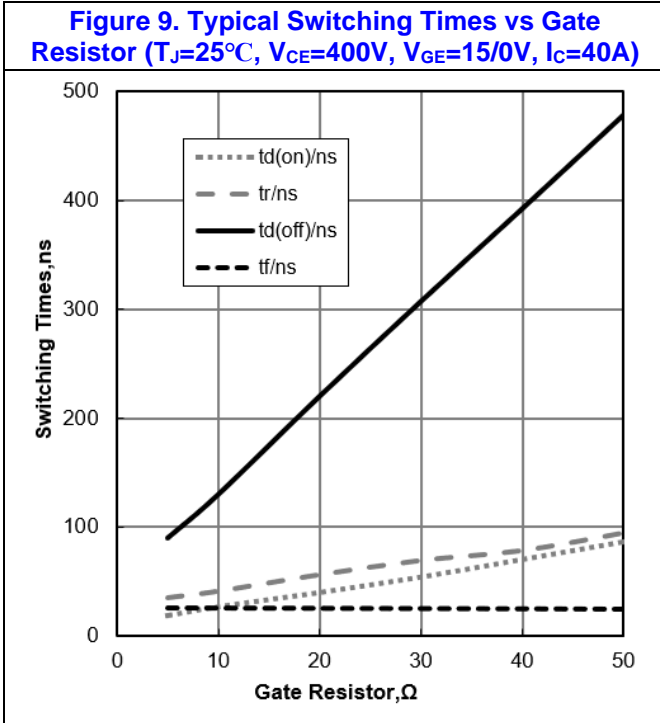

Figure 13. Typical Switching Times vs Collector Current ($T_J=25^\circ\text{C}$, $V_{CE}=400\text{V}$, $V_{GE}=15/0\text{V}$)

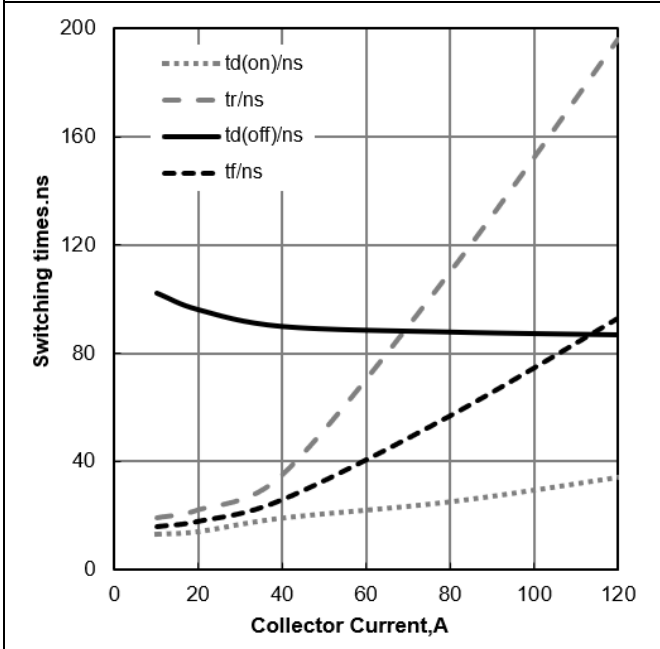

Figure 14. Typical Switching Energy vs Collector Current ($T_J=25^\circ\text{C}$, $V_{CE}=400\text{V}$, $V_{GE}=15/0\text{V}$)

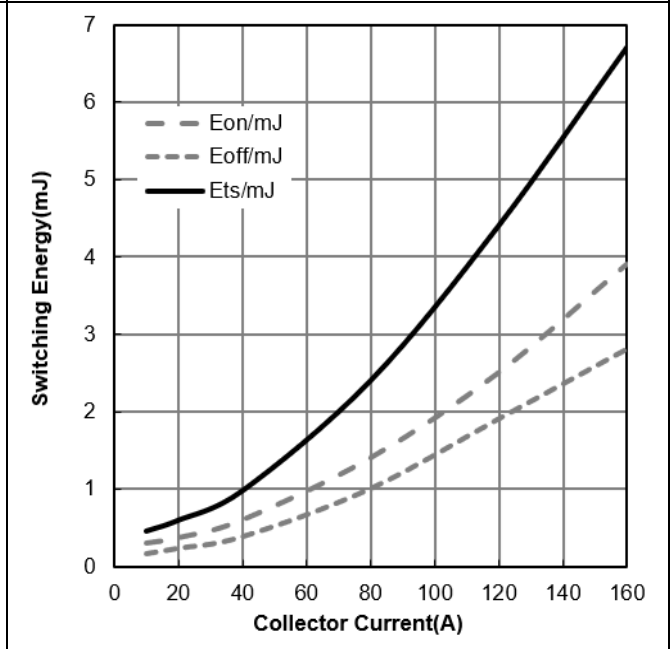

Figure 15. Typical Switching Times vs V_{CE} ($T_J=25^\circ\text{C}$, $V_{GE}=15/0\text{V}$, $I_C=40\text{A}$)

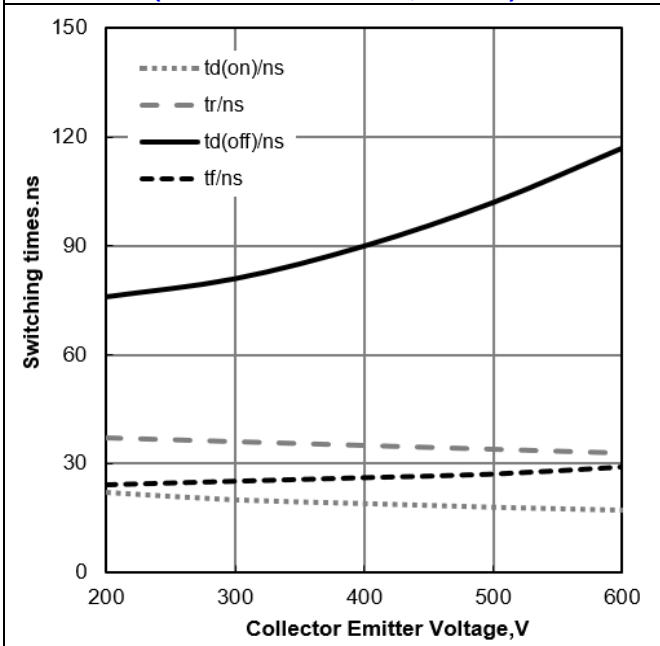

Figure 16. Typical Switching Energy vs V_{CE} ($T_J=25^\circ\text{C}$, $V_{GE}=15/0\text{V}$, $I_C=40\text{A}$)

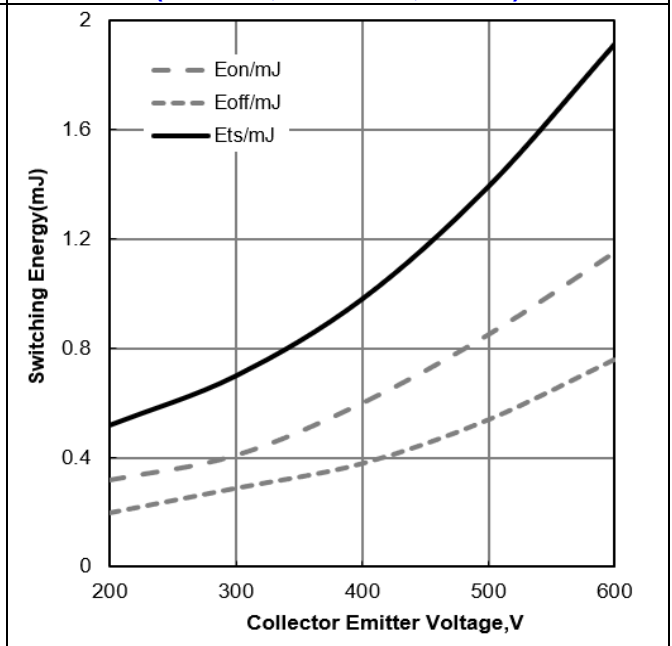

Figure 17. Typical Gate Charge

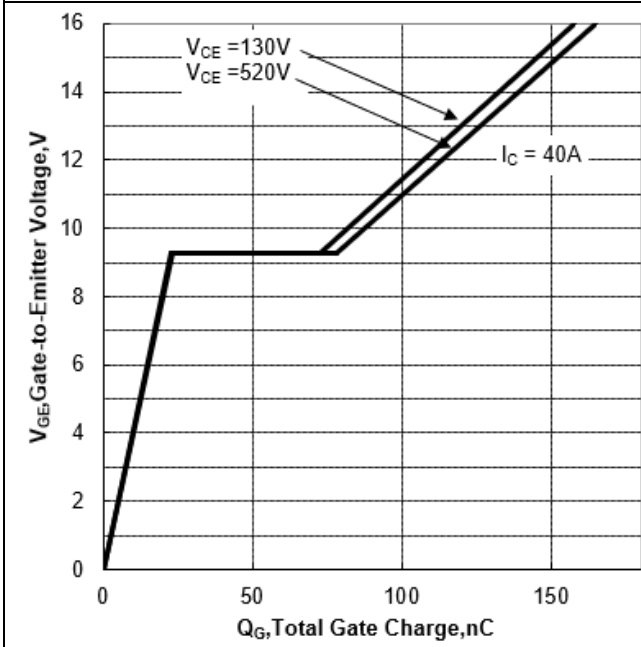

Figure 18. Typical Capacitance vs Collector-Emitter Voltage

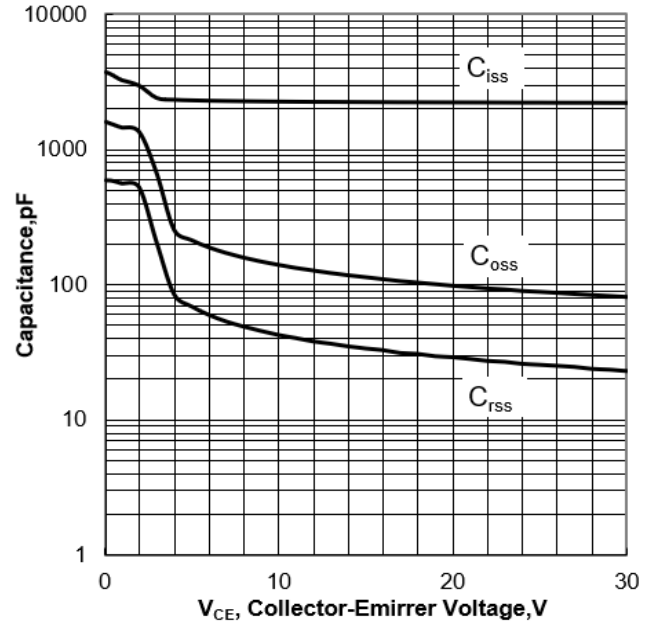

Figure 19. IGBT Transient Thermal Impedance vs Pulse Width(TO3PN/TO247)

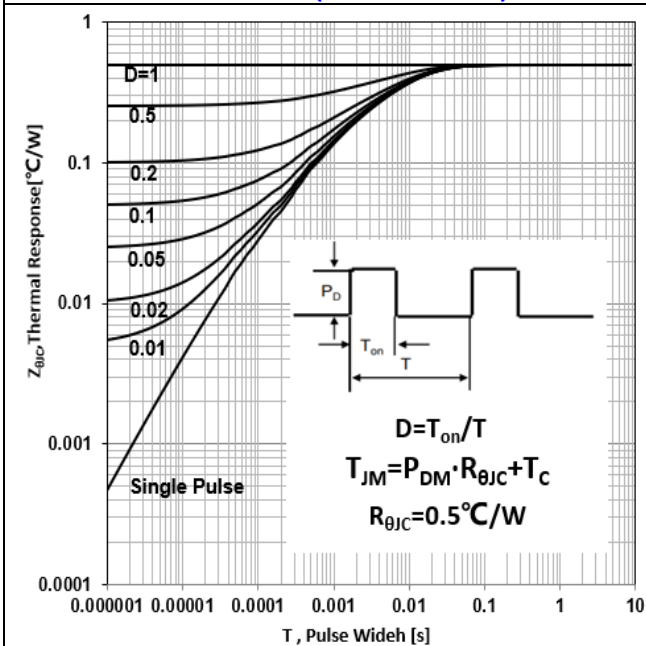

Figure 20. Diode Transient Thermal Impedance vs Pulse Width(TO3PN/TO247)

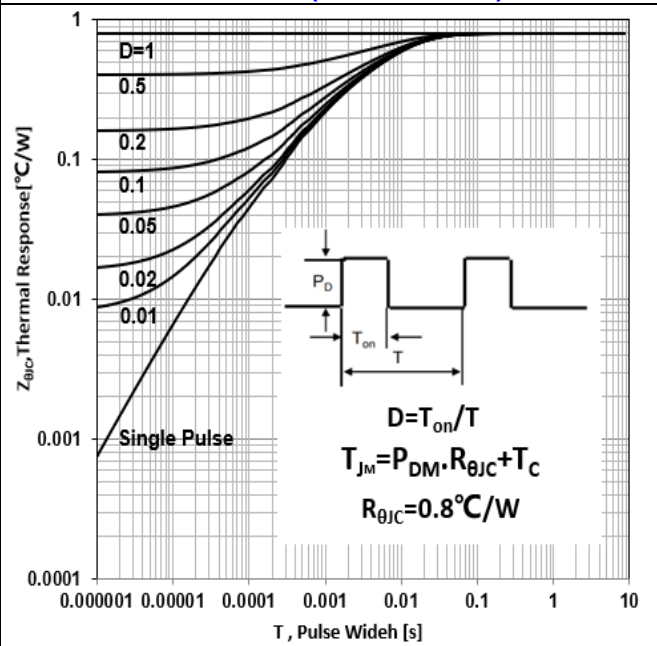
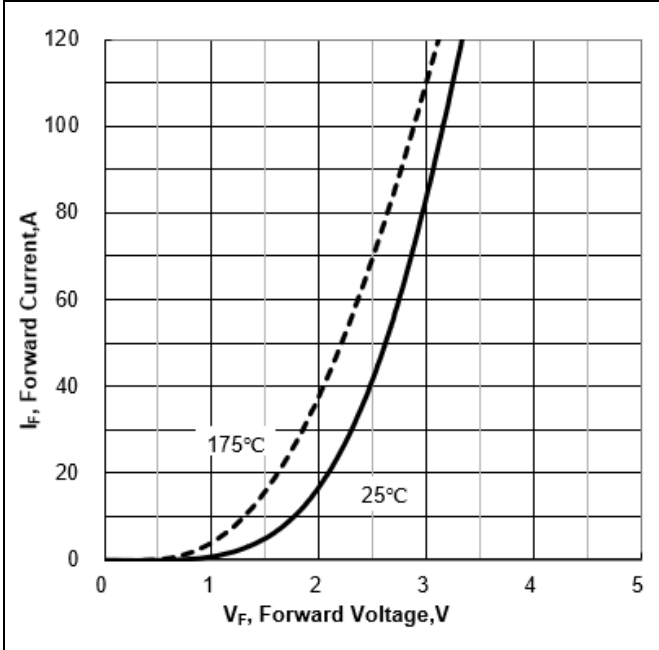
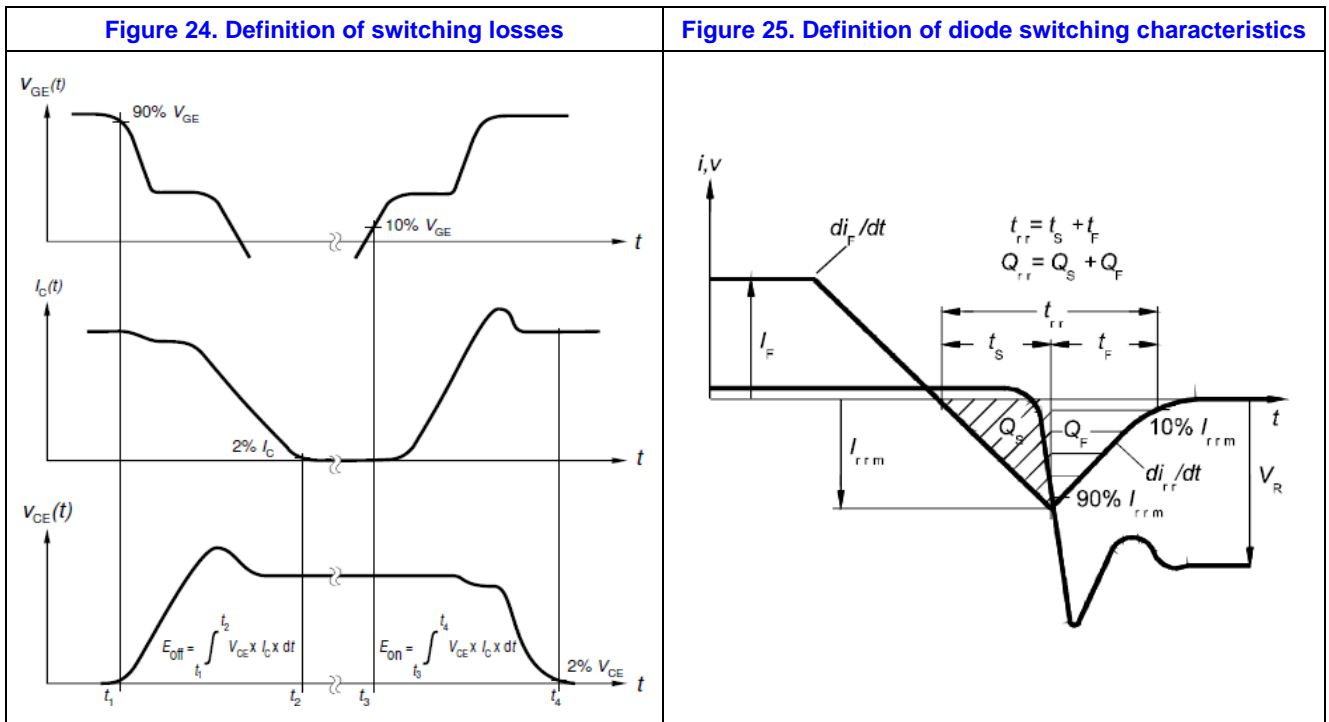
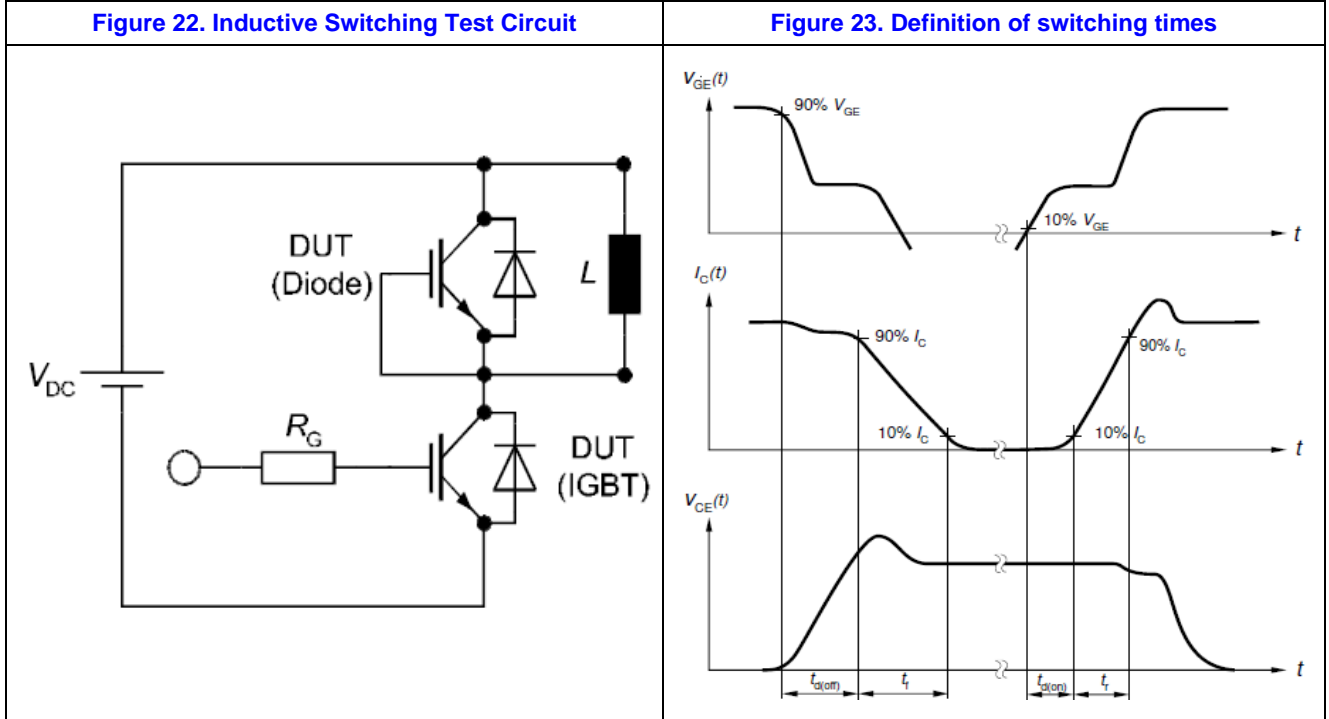

Figure 21. Typical Diode Forward Current vs Forward Voltage



6. Test Circuit and Waveform



7. Package Description

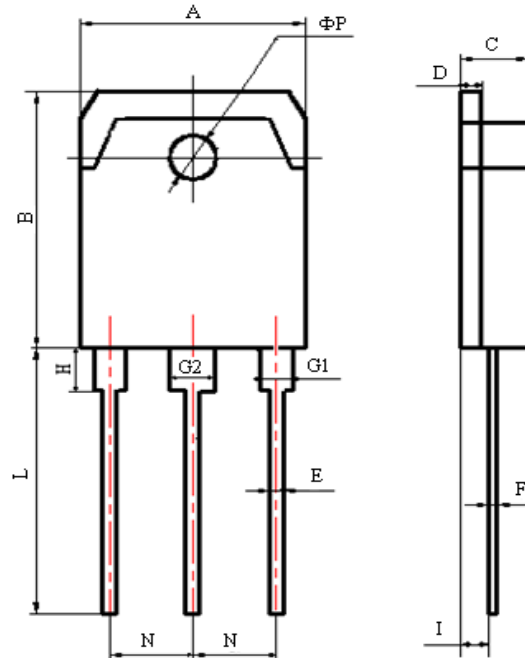

TO-3PN Package

Items	Values(mm)	
	MIN	MAX
A	15.00	16.00
B	19.20	20.60
C	4.60	5.00
D	1.40	1.60
E	0.90	1.10
F	0.50	0.70
G1	2.00	2.20
G2	3.00	3.20
H	3.00	3.70
I	1.20	1.70
	2.70	2.90
L	19.00	21.00
N	5.25	5.65
ΦP	3.10	3.30

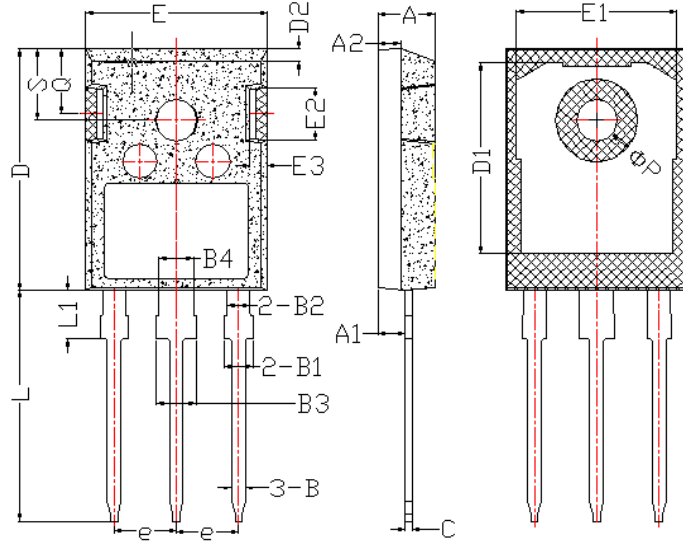

TO-247 Package

Items	Values(mm)	
	MIN	MAX
A	4.90	5.16
A1	2.27	2.53
A2	1.85	2.11
B	1.07	1.33
B1	1.90	2.41
B2	1.75	2.15
B3	2.87	3.38
B4	2.87	3.13
C	0.55	0.68
D	20.82	21.10
D1	16.25	17.65
D2	1.05	1.35
E	15.70	16.03
E1	13.10	14.15
E2	3.68	5.10
E3	1.68	2.60
e	5.44	
L	19.80	20.31
L1	4.17	4.47
ΦP	3.50	3.70
Q	5.49	6.00
S	6.04	6.30