

Super Low On Resistance / Low Voltage 1 A LDO for Automotive Applications

NO. EC-122-140219

OUTLINE

The R1172x is a CMOS-based positive voltage regulator IC that is specifically designed for automotive applications. The R1172x has features of super low dropout, 1A output current capability. Even the output voltage is set at 1.5V, on resistance of internal FET is typically 0.32Ω . Therefore, applications that require a large current at small dropout are suitable for the R1172x. Low input voltage is acceptable and low output voltage can be set. The minimum input voltage is 1.4V, and the lowest set output voltage is 0.8V. Each of these ICs consists of a voltage reference unit, an error amplifier, resistor net for setting output voltage, a current limit circuit at over-current, a chip enable circuit, a thermal-shutdown circuit, and so on. A stand-by mode with ultra low consumption current can be realized with the chip enable pin. The output voltage of R1172 is fixed in the IC.

Since the packages for this IC are SOT-23-5, SOT-89-5, and HSOP-6J with high power dissipation, high density mounting of the ICs on boards is possible.

FEATURES

- Input Voltage Range (Maximum Rating) 1.4V to 6.0V (6.5V)
- Output Current 1A
- Supply Current Typ. 60 μ A
- Standby Current Typ. 0.1 μ A
- Output Voltage..... 0.8V to 5.0V (0.1V step)
(For other voltages, refer to *SELECTION GUIDE*).
- Dropout Voltage..... Typ. 0.32V ($V_{SET}=1.5V, I_{OUT}=1A$)
Typ. 0.18V ($V_{SET}=2.8V, I_{OUT}=1A$)
- Ripple Rejection Typ. 70dB ($V_{SET}=2.8V$)
- Output Voltage Accuracy $\pm 2.0\%$
- Output Voltage Temperature Coefficient Typ. $\pm 100\text{ppm}/^\circ\text{C}$
- Line Regulation Typ. 0.05%/V
- Load Regulation Typ. 15mV at $I_{OUT}=300\text{mA}$, Typ. 50mV at $I_{OUT}=1A$
- Output Noise 30 μVrms
- Packages SOT-23-5, SOT-89-5, HSOP-6J
- Built-in Inrush current limit circuit Typ. 500 mA
- Built-in Fold-Back Protection Circuit Typ. 250mA (Current at short mode)
- Built-in Thermal Shutdown Circuit Thermal Shutdown Temperature: Typ. 150 $^\circ\text{C}$
Released Temperature: Typ. 120 $^\circ\text{C}$
- Built-in Auto Discharge Function R1172xxxxD
- Output capacitors $C_{IN}=C_{OUT}=\text{Tantalum } 4.7\mu\text{F}$ ($V_{OUT} < 1.0V$)
 $C_{IN}=C_{OUT}=\text{Ceramic } 4.7\mu\text{F}$ ($V_{OUT} \geq 1.0V$)

APPLICATIONS

- Power source for car accessories including car audio equipment, car navigation system, and ETC system.

R1172x

NO. EC-128-140219

BLOCK DIAGRAMS

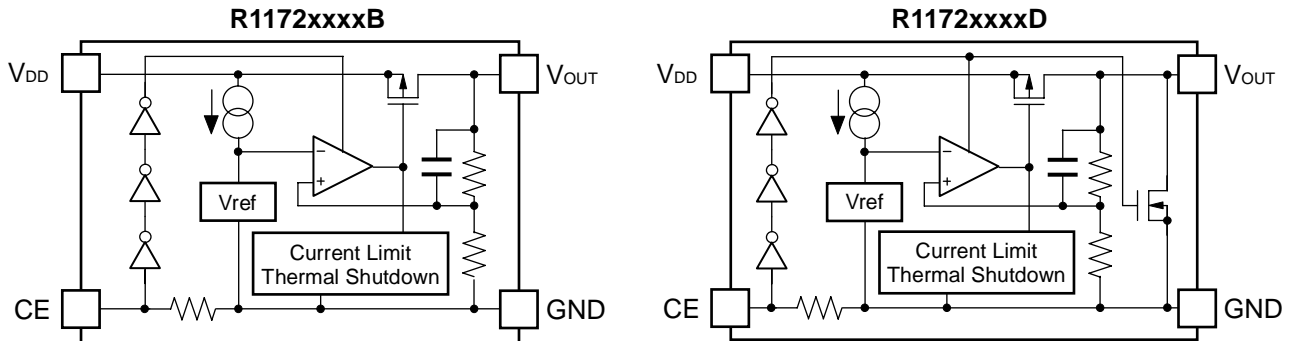

SELECTION GUIDE

The output voltage, chip-enable polarity, auto discharge function^{*1}, and package for the ICs can be selected at the user's request.

Product Name	Package	Quantity per Reel	Pb Free	Halogen Free
R1172Nxx1*(y)-TR-#E	SOT-23-5	3,000 pcs	Yes	Yes
R1172Hxx2*(y)-T1-#E	SOT-89-5	1,000 pcs	Yes	Yes
R1172Sxx2*(y)-E2-#E	HSOP-6J	1,000 pcs	Yes	Yes

xx: The set output voltage (V_{SET}) can be designated in the range from 0.8V(08) to 5.0V(50) in 0.1V step.

(y): If the set output voltage includes the third digit, indicate the digit of 0.01 (1.25 V, 1.85 V, 2.85 V).

Ex. If the set output voltage is 1.25 V: R1172x121x5, R1172x122x5

If the set output voltage is 1.85 V: R1172x181x5, R1172x182x5

If the set output voltage is 2.85 V: R1172x281x5, R1172x282x5

* : Options of the auto discharge function at off state are as follows.

(B) Active-high

(D) Active-high with auto discharge function at off state

#: Specify the automotive class code.

	Operating Temperature Range	Guaranteed Specs Temperature Range	Screening
A	-40°C to 85°C	25°C	High temperature
H	-40°C to 85°C	25°C	High and low temperature

Automotive class code (A, H) varies depending on the products.

Product Name	Automotive Class Code	
	A	H
R1172Nxx1*(y)-TR-#E		✓
R1172Hxx2*(y)-T1-#E	✓	✓
R1172Sxx2*(y)-E2-#E	✓	

^{*1} Auto-discharge function quickly lowers the output voltage to 0V by releasing the electrical charge accumulated in the external capacitor when the chip enable signal is switched from the active mode to the standby mode.

PIN DESCRIPTIONS

● SOT-23-5

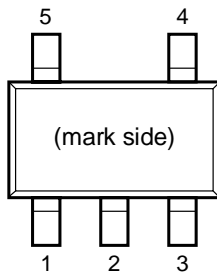

● SOT-89-5

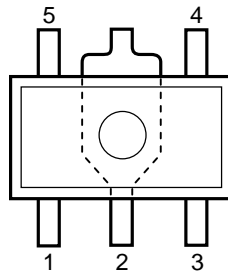

● HSOP-6J

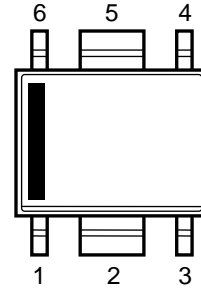

SOT-23-5

Pin No.	Symbol	Description
1	V_{OUT}	Output Pin
2	GND	Ground Pin
3	V_{DD}	Input Pin
4	NC	No Connection
5	CE	Chip Enable Pin

● SOT-89-5

Pin No.	Symbol	Description
1	CE	Chip Enable Pin
2	GND	Ground Pin
3	GND	Ground Pin
4	V_{DD}	Input Pin
5	V_{OUT}	Output Pin

The GND pin must be wired together when it is mounted on board.

HSOP-6J

Pin No.	Symbol	Description
1	V_{OUT}	Output Pin
2	GND	Ground Pin
3	CE	Chip Enable Pin
4	GND	Ground Pin
5	GND	Ground Pin
6	V_{DD}	Input Pin

The GND pin must be wired together when it is mounted on board.

ABSOLUTE MAXIMUM RATINGS

Symbol	Item		Rating	Unit	
V_{IN}	Input Voltage		6.5	V	
V_{CE}	Input Voltage (CE Input Pin)		-0.3 to 6.5	V	
V_{OUT}	Output Voltage		-0.3 to $V_{IN}+0.3$	V	
P_D	Power Dissipation ^{*1}	SOT-23-5	Standard Land Pattern	420	mW
		SOT-89-5	Standard Land Pattern	900	
			High Wattage Land Pattern	1300	
		HSOP-6J	Standard Land Pattern	1700	
Ultra High Wattage Land Pattern	2700				
T_j	Junction Temperature		-40 to 125	°C	
T_{stg}	Storage Temperature Range		-55 to 125	°C	

^{*1} Refer to *PACKAGE INFORMATION* for detailed information.

ABSOLUTE MAXIMUM RATINGS

Electronic and mechanical stress momentarily exceeded absolute maximum ratings may cause the permanent damages and may degrade the life time and safety for both device and system using the device in the field. The functional operation at or over these absolute maximum ratings is not assured.

RECOMMENDED OPERATING RATINGS

Symbol	Item	Rating	Unit
V_{IN}	Input Voltage	1.4 to 6.0	V
T_a	Operating Temperature Range	-40 to 85	°C

RECOMMENDED OPERATING RATINGS

All of electronic equipment should be designed that the mounted semiconductor devices operate within the recommended operating ratings. The semiconductor devices cannot operate normally over the recommended operating ratings, even if when they are used over such ratings by momentary electronic noise or surge. And the semiconductor devices may receive serious damage when they continue to operate over the recommended operating ratings.

ELECTRICAL CHARACTERISTICS

● R1172xxxxB/D

(Ta=25°C)

Symbol	Item	Conditions	Min.	Typ.	Max.	Unit	
I _{SS}	Supply Current	V _{IN} -V _{SET} =1.0V, V _{IN} =V _{CE} , I _{OUT} =0A		60	100	μA	
I _{standby}	Standby Current	V _{IN} = 6.0V, V _{CE} =0V		0.1	1.0	μA	
V _{OUT}	Output Voltage	V _{IN} -V _{SET} =1.0V	V _{SET} > 1.5V	×0.98	×1.02	V	
		I _{OUT} =100mA	V _{SET} ≤ 1.5V	-30	30	mV	
ΔV _{OUT} / ΔI _{OUT}	Load Regulation	V _{IN} -V _{SET} =0.3V 1mA ≤ I _{OUT} ≤ 300mA If V _{SET} ≤ 1.1V, then V _{IN} =1.4V		-15	15	30	mV
		V _{IN} -V _{SET} =0.3V 1mA ≤ I _{OUT} ≤ 1A If V _{SET} ≤ 1.1V, then V _{IN} =1.7V			50		
V _{DIF}	Dropout Voltage	Refer to the <i>Product-specific Electrical Characteristics</i>					
ΔV _{OUT} / ΔV _{IN}	Line Regulation	I _{OUT} =100mA V _{SET} +0.5V ≤ V _{IN} ≤ 6.0V If V _{SET} ≤ 0.9V, 1.4V ≤ V _{IN} ≤ 6.0V		0.05	0.20	%/V	
I _{LIM}	Output Current Limit	V _{IN} -V _{SET} =1.0V	1			A	
I _{SC}	Short Current	V _{OUT} =0V		250		mA	
R _{PD}	Pull-down Resistance for CE pin		1.9	5.0	15.0	MΩ	
V _{CEH}	CE Input Voltage "H"		1.0		6.0	V	
V _{CEL}	CE Input Voltage "L"		0		0.4	V	
T _{TSD}	Thermal Shutdown Temperature	Junction Temperature		150		°C	
T _{TSR}	Thermal Shutdown Released Temperature	Junction Temperature		120		°C	

R1172x

NO. EC-128-140219

Product-specific Electrical Characteristics

(Ta=25°C)

Product Name	V _{OUT} [V]			V _{DIF} [V]		
				I _{OUT} = 300 mA		I _{OUT} = 1 A
	MIN.	TYP.	MAX.	TYP.	MAX.	TYP.
R1172x08xx	0.770	0.800	0.830	0.33	0.57	0.72
R1172x09xx	0.870	0.900	0.930	0.22	0.47	0.64
R1172x10xx	0.970	1.000	1.030	0.18	0.32	0.56
R1172x11xx	1.070	1.100	1.130			
R1172x12xx	1.170	1.200	1.230			
R1172x12xx5	1.220	1.250	1.280			
R1172x13xx	1.270	1.300	1.330			
R1172x14xx	1.370	1.400	1.430			
R1172x15xx	1.470	1.500	1.530			
R1172x16xx	1.568	1.600	1.632	0.10	0.15	0.32
R1172x17xx	1.666	1.700	1.734			
R1172x18xx	1.764	1.800	1.836			
R1172x18xx5	1.813	1.850	1.887			
R1172x19xx	1.862	1.900	1.938			
R1172x20xx	1.960	2.000	2.040			
R1172x21xx	2.058	2.100	2.142			
R1172x22xx	2.156	2.200	2.244			
R1172x23xx	2.254	2.300	2.346			
R1172x24xx	2.352	2.400	2.448			
R1172x25xx	2.450	2.500	2.550			
R1172x26xx	2.548	2.600	2.652	0.05	0.10	0.18
R1172x27xx	2.646	2.700	2.754			
R1172x28xx	2.744	2.800	2.856			
R1172x28xx5	2.793	2.850	2.907			
R1172x29xx	2.842	2.900	2.958			
R1172x30xx	2.940	3.000	3.060			
R1172x31xx	3.038	3.100	3.162			
R1172x32xx	3.136	3.200	3.264			
R1172x33xx	3.234	3.300	3.366			
R1172x34xx	3.332	3.400	3.468			
R1172x35xx	3.430	3.500	3.570			
R1172x36xx	3.528	3.600	3.672			
R1172x37xx	3.626	3.700	3.774			
R1172x38xx	3.724	3.800	3.876			
R1172x39xx	3.822	3.900	3.978			

(Ta=25°C)

Product Name	V _{OUT} [V]			V _{DIF} [V]		
				I _{OUT} = 300 mA		I _{OUT} = 1 A
	MIN.	TYP.	MAX.	TYP.	MAX.	TYP.
R1172x40xx	3.920	4.000	4.080	0.05	0.10	0.18
R1172x41xx	4.018	4.100	4.182			
R1172x42xx	4.116	4.200	4.284			
R1172x43xx	4.214	4.300	4.386			
R1172x44xx	4.312	4.400	4.488			
R1172x45xx	4.410	4.500	4.590			
R1172x46xx	4.508	4.600	4.692			
R1172x47xx	4.606	4.700	4.794			
R1172x48xx	4.704	4.800	4.896			
R1172x49xx	4.802	4.900	4.998			
R1172x50xx	4.900	5.000	5.100			

TYPICAL APPLICATION (R1172xxxxB/D)

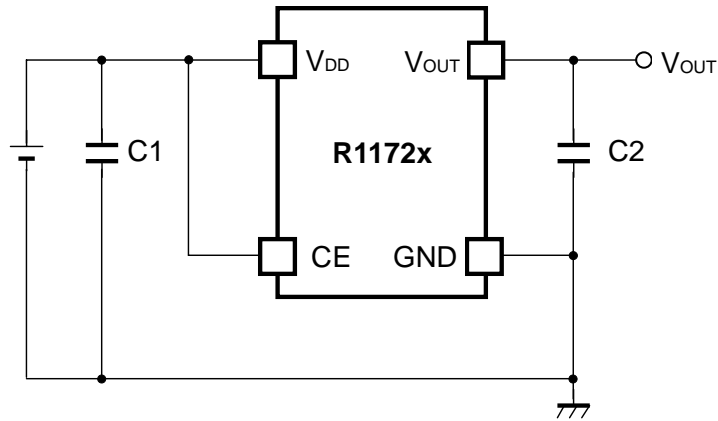

TECHNICAL NOTES

When using these ICs, consider the following points:

PCB Layout

Make V_{DD} and GND lines sufficient. If their impedance is high, noise pickup or unstable operation may result. Connect a capacitor C1 with a capacitance value as much as $4.7\mu\text{F}$ or more between V_{DD} and GND, and as close as possible to the pins (refer to *TYPICAL APPLICATION*).

Phase Compensation

In these ICs, phase compensation is made for securing stable operation even if the load current is varied. For this purpose, use a capacitor C2 with good frequency characteristics and ESR (Equivalent Series Resistance).

The recommendation value is as follows.

Output Voltage	C2 recommendation value	Components Recommendation
$V_{OUT} < 1.0\text{V}$	Tantalum $4.7\mu\text{F}$ or more	
$1.0 \leq V_{OUT} \leq 3.3\text{V}$	Ceramic $4.7\mu\text{F}$ or more	Kyocera $4.7\mu\text{F}$ (1608) Part Number : CM105X5R475M06AB Murata $4.7\mu\text{F}$ (1608) Part Number : GRM188R60J475KE19B Murata $10\mu\text{F}$ (1608) Part Number : GRM188B30G106ME46B
$3.3\text{V} < V_{OUT}$	Ceramic $4.7\mu\text{F}$ or more	Kyocera $4.7\mu\text{F}$ (thin 2012) Part Number : CT21X5R475M06AB Murata $10\mu\text{F}$ (2012) Part Number : GRM21BB30J106K

* If you use a tantalum type capacitor and ESR value of the capacitor is large, output might be unstable. Evaluate your circuit with considering frequency characteristics.

* Depending on the capacitor size, manufacturer, and part number, the bias characteristics and temperature characteristics are different. Evaluate the circuit with actual using capacitors.

TYPICAL APPLICATION FOR IC CHIP BREAKDOWN PREVENTION

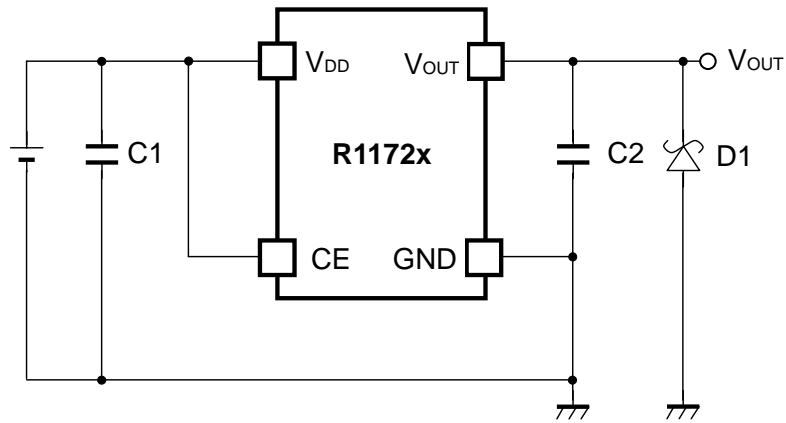

When a sudden surge of electrical current travels along the V_{OUT} pin and GND due to a short-circuit, electrical resonance of a circuit involving an output capacitor (C2) and a short circuit inductor generates a negative voltage and may damage the device or the load devices. Connecting a schottky diode (D1) between the V_{OUT} pin and GND has the effect of preventing damage to them.

PACKAGE INFORMATION

POWER DISSIPATION (SOT-23-5)

Power Dissipation (P_D) depends on conditions of mounting on board. This specification is based on the measurement at the condition below:

(Power Dissipation (SOT-23-5) is substitution of SOT-23-6).

* Measurement Conditions

	Standard Test Land Pattern
Environment	Mounting on Board (Wind velocity=0m/s)
Board Material	Glass cloth epoxy plastic (Double sided)
Board Dimensions	40mm x 40mm x 1.6mm
Copper Ratio	Top side: Approx. 50%, Back side: Approx. 50%
Through-holes	ϕ 0.5mm x 44pcs

* Measurement Result: (Ta=25°C, Tjmax=125°C)

	Standard Land Pattern	Free Air
Power Dissipation	420mW	250mW
Thermal Resistance	$\theta_{ja} = (125-25^\circ\text{C})/0.42\text{W} = 238^\circ\text{C/W}$	400°C/W

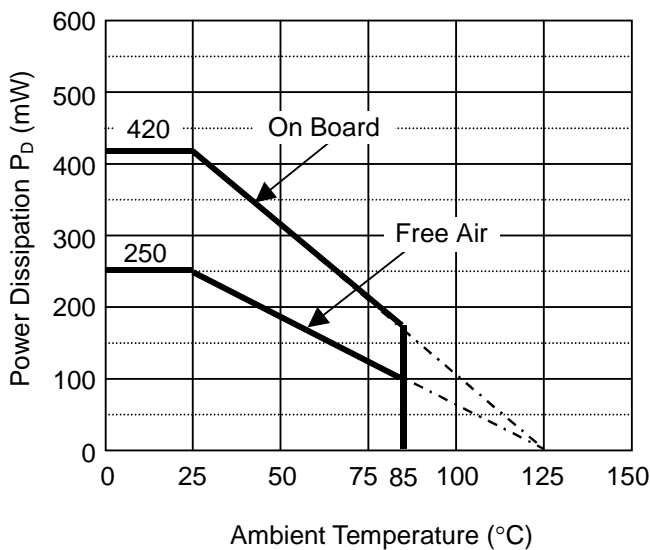

Power Dissipation

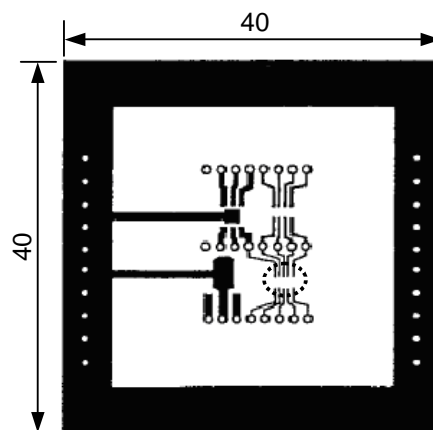

Measurement Board Pattern

○ IC Mount Area (Unit: mm)

PACKAGE DIMENSIONS (SOT-23-5)

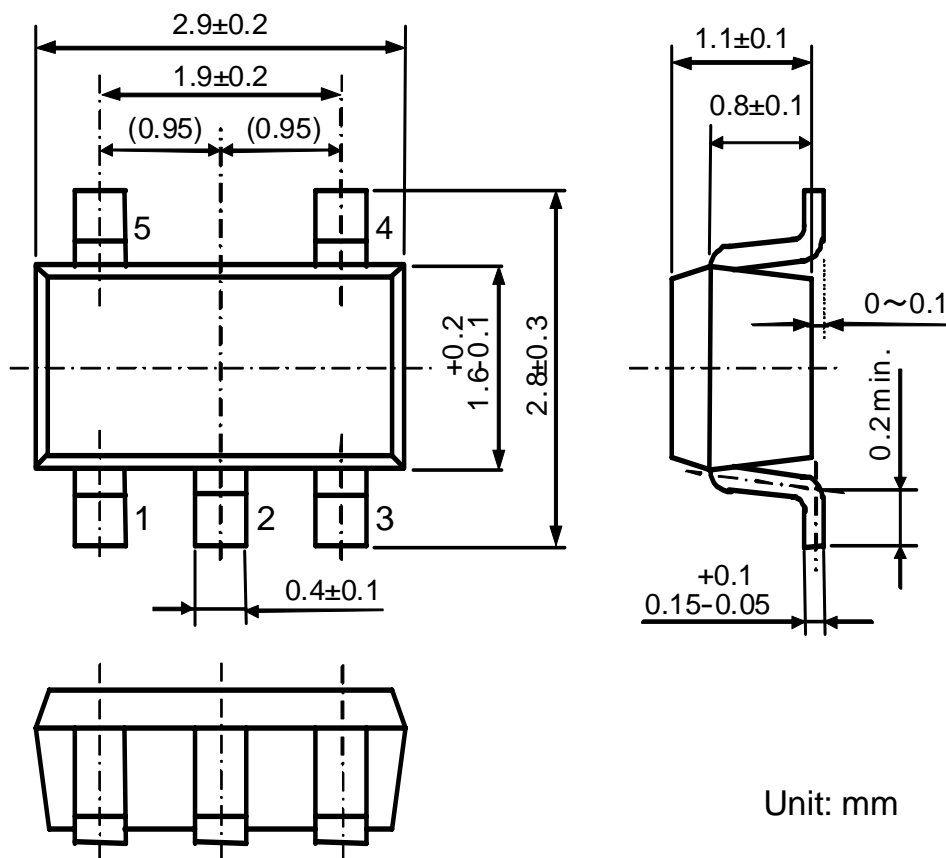

MARK SPECIFICATION (SOT-23-5)

①②③: Product Code ... Refer to MARK SPECIFICATION TABLE (SOT-23-5)

④⑤: Lot Number ... Alphanumeric Serial Number

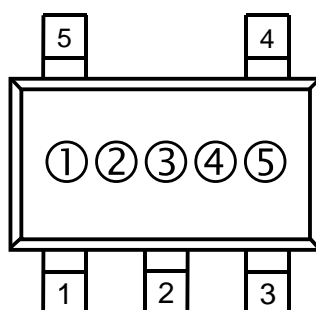

R1172x

NO. EC-128-140219

MARK SPECIFICATION TABLE (SOT-23-5)

Product Name	①②③	V _{SET}
R1172N081B	Y 4 8	0.8 V
R1172N091B	Y 4 9	0.9 V
R1172N101B	Y 5 0	1.0 V
R1172N111B	Y 5 1	1.1 V
R1172N121B	Y 5 2	1.2 V
R1172N131B	Y 5 3	1.3 V
R1172N141B	Y 5 4	1.4 V
R1172N151B	Y 5 5	1.5 V
R1172N161B	Y 5 6	1.6 V
R1172N171B	Y 5 7	1.7 V
R1172N181B	Y 5 8	1.8 V
R1172N191B	Y 5 9	1.9 V
R1172N201B	Y 6 0	2.0 V
R1172N211B	Y 6 1	2.1 V
R1172N221B	Y 6 2	2.2 V
R1172N231B	Y 6 3	2.3 V
R1172N241B	Y 6 4	2.4 V
R1172N251B	Y 6 5	2.5 V
R1172N261B	Y 6 6	2.6 V
R1172N271B	Y 6 7	2.7 V
R1172N281B	Y 6 8	2.8 V
R1172N291B	Y 6 9	2.9 V
R1172N301B	Y 7 0	3.0 V
R1172N311B	Y 7 1	3.1 V
R1172N321B	Y 7 2	3.2 V
R1172N331B	Y 7 3	3.3 V
R1172N341B	Y 7 4	3.4 V
R1172N351B	Y 7 5	3.5 V
R1172N361B	Y 7 6	3.6 V
R1172N371B	Y 7 7	3.7 V
R1172N381B	Y 7 8	3.8 V
R1172N391B	Y 7 9	3.9 V
R1172N401B	Y 8 0	4.0 V
R1172N411B	Y 8 1	4.1 V
R1172N421B	Y 8 2	4.2 V
R1172N431B	Y 8 3	4.3 V
R1172N441B	Y 8 4	4.4 V
R1172N451B	Y 8 5	4.5 V
R1172N461B	Y 8 6	4.6 V
R1172N471B	Y 8 7	4.7 V
R1172N481B	Y 8 8	4.8 V
R1172N491B	Y 8 9	4.9 V
R1172N501B	Y 9 0	5.0 V
R1172N181B5	Y 4 0	1.85 V
R1172N281B5	Y 4 1	2.85 V
R1172N121B5	Y 4 2	1.25 V

Product Name	①②③	V _{SET}
R1172N081D	Z 4 8	0.8 V
R1172N091D	Z 4 9	0.9 V
R1172N101D	Z 5 0	1.0 V
R1172N111D	Z 5 1	1.1 V
R1172N121D	Z 5 2	1.2 V
R1172N131D	Z 5 3	1.3 V
R1172N141D	Z 5 4	1.4 V
R1172N151D	Z 5 5	1.5 V
R1172N161D	Z 5 6	1.6 V
R1172N171D	Z 5 7	1.7 V
R1172N181D	Z 5 8	1.8 V
R1172N191D	Z 5 9	1.9 V
R1172N201D	Z 6 0	2.0 V
R1172N211D	Z 6 1	2.1 V
R1172N221D	Z 6 2	2.2 V
R1172N231D	Z 6 3	2.3 V
R1172N241D	Z 6 4	2.4 V
R1172N251D	Z 6 5	2.5 V
R1172N261D	Z 6 6	2.6 V
R1172N271D	Z 6 7	2.7 V
R1172N281D	Z 6 8	2.8 V
R1172N291D	Z 6 9	2.9 V
R1172N301D	Z 7 0	3.0 V
R1172N311D	Z 7 1	3.1 V
R1172N321D	Z 7 2	3.2 V
R1172N331D	Z 7 3	3.3 V
R1172N341D	Z 7 4	3.4 V
R1172N351D	Z 7 5	3.5 V
R1172N361D	Z 7 6	3.6 V
R1172N371D	Z 7 7	3.7 V
R1172N381D	Z 7 8	3.8 V
R1172N391D	Z 7 9	3.9 V
R1172N401D	Z 8 0	4.0 V
R1172N411D	Z 8 1	4.1 V
R1172N421D	Z 8 2	4.2 V
R1172N431D	Z 8 3	4.3 V
R1172N441D	Z 8 4	4.4 V
R1172N451D	Z 8 5	4.5 V
R1172N461D	Z 8 6	4.6 V
R1172N471D	Z 8 7	4.7 V
R1172N481D	Z 8 8	4.8 V
R1172N491D	Z 8 9	4.9 V
R1172N501D	Z 9 0	5.0 V
R1172N181D5	Z 4 0	1.85 V
R1172N281D5	Z 4 1	2.85 V
R1172N121D5	Z 4 2	1.25 V

POWER DISSIPATION (SOT-89-5)

Power Dissipation (P_D) depends on conditions of mounting on board. This specification is based on the measurement at the condition below:

Measurement Conditions

	High Wattage Land Pattern	Standard Land Pattern
Environment	Mounting on Board (Wind velocity=0m/s)	Mounting on Board (Wind velocity=0m/s)
Board Material	Glass cloth epoxy plastic (Double sided)	Glass cloth epoxy plastic (Double sided)
Board Dimensions	30mm × 30mm × 1.6mm	50mm × 50mm × 1.6mm
Copper Ratio	Top side : Approx. 20% , Back side : Approx. 100%	Top side : Approx. 10% , Back side : Approx. 100%
Through-hole	φ0.85mm × 10pcs	-

Measurement Result

($T_a=25^{\circ}\text{C}$, $T_{j\text{max}}=125^{\circ}\text{C}$)

	High Wattage Land Pattern	Standard Land Pattern	Free Air
Power Dissipation	1300mW	900mW	500mW
Thermal Resistance	77°C/W	111°C/W	200°C/W

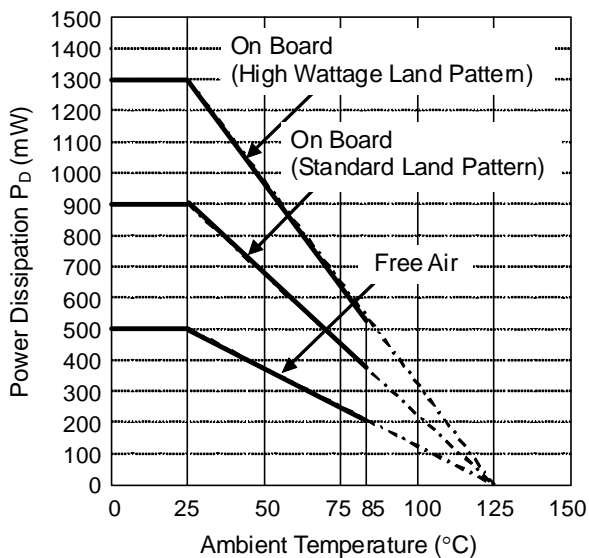

Power Dissipation

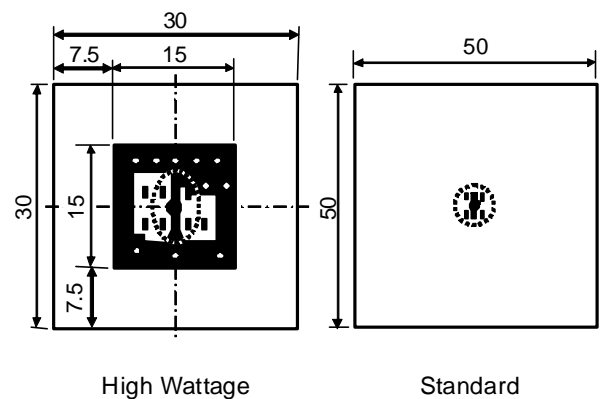

Measurement Board Pattern

 IC Mount Area (Unit: mm)

PACKAGE DIMENSIONS (SOT-89-5)

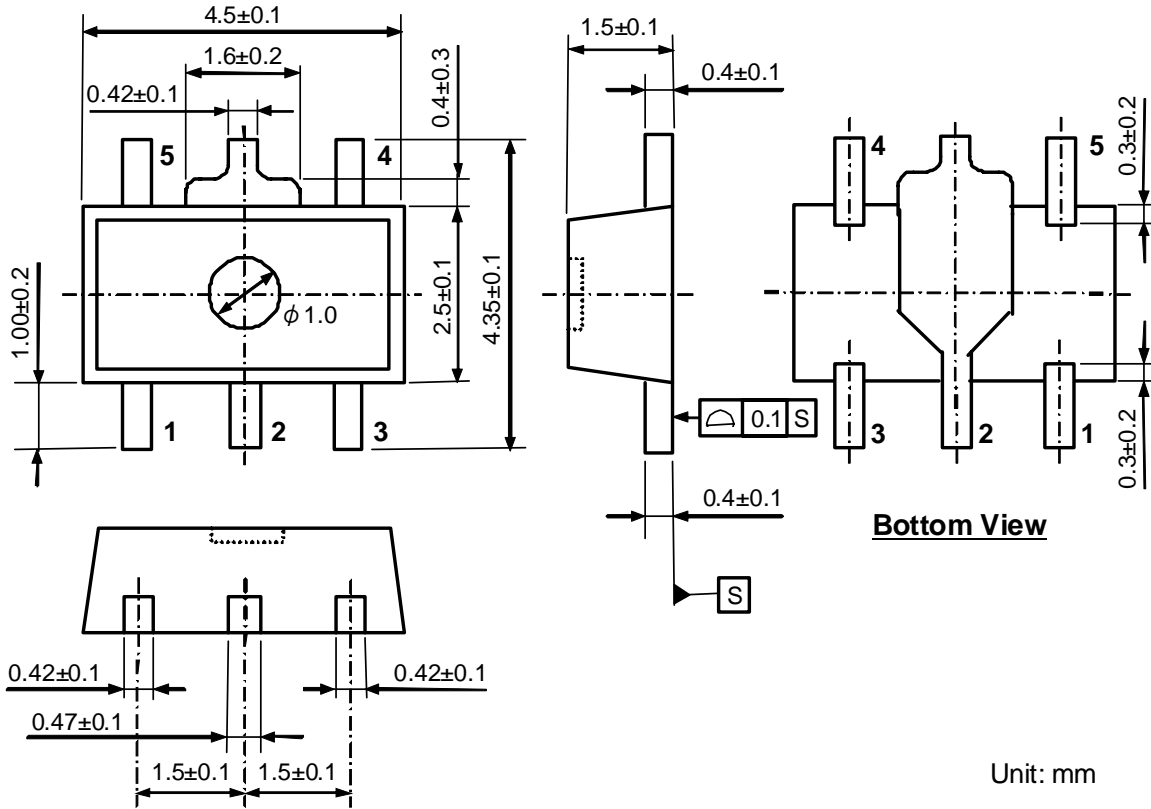

MARK SPECIFICATION (SOT-89-5)

①②③④: Product Code ... Refer to MARK SPECIFICATION TABLE (SOT-89-5)

⑤⑥: Lot Number ... Alphanumeric Serial Number

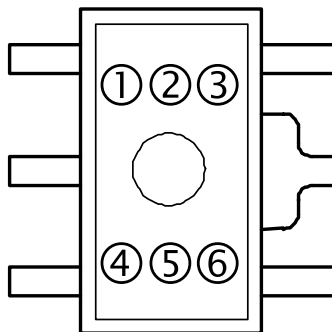

MARK SPECIFICATION TABLE (SOT-89-5)

Product Name	①②③④	V _{SET}	Product Name	①②③④	V _{SET}
R1172H082B	J 0 8 E	0.8 V	R1172H082D	J 0 8 F	0.8 V
R1172H092B	J 0 9 E	0.9 V	R1172H092D	J 0 9 F	0.9 V
R1172H102B	J 1 0 E	1.0 V	R1172H102D	J 1 0 F	1.0 V
R1172H112B	J 1 1 E	1.1 V	R1172H112D	J 1 1 F	1.1 V
R1172H122B	J 1 2 E	1.2 V	R1172H122D	J 1 2 F	1.2 V
R1172H132B	J 1 3 E	1.3 V	R1172H132D	J 1 3 F	1.3 V
R1172H142B	J 1 4 E	1.4 V	R1172H142D	J 1 4 F	1.4 V
R1172H152B	J 1 5 E	1.5 V	R1172H152D	J 1 5 F	1.5 V
R1172H162B	J 1 6 E	1.6 V	R1172H162D	J 1 6 F	1.6 V
R1172H172B	J 1 7 E	1.7 V	R1172H172D	J 1 7 F	1.7 V
R1172H182B	J 1 8 E	1.8 V	R1172H182D	J 1 8 F	1.8 V
R1172H192B	J 1 9 E	1.9 V	R1172H192D	J 1 9 F	1.9 V
R1172H202B	J 2 0 E	2.0 V	R1172H202D	J 2 0 F	2.0 V
R1172H212B	J 2 1 E	2.1 V	R1172H212D	J 2 1 F	2.1 V
R1172H222B	J 2 2 E	2.2 V	R1172H222D	J 2 2 F	2.2 V
R1172H232B	J 2 3 E	2.3 V	R1172H232D	J 2 3 F	2.3 V
R1172H242B	J 2 4 E	2.4 V	R1172H242D	J 2 4 F	2.4 V
R1172H252B	J 2 5 E	2.5 V	R1172H252D	J 2 5 F	2.5 V
R1172H262B	J 2 6 E	2.6 V	R1172H262D	J 2 6 F	2.6 V
R1172H272B	J 2 7 E	2.7 V	R1172H272D	J 2 7 F	2.7 V
R1172H282B	J 2 8 E	2.8 V	R1172H282D	J 2 8 F	2.8 V
R1172H292B	J 2 9 E	2.9 V	R1172H292D	J 2 9 F	2.9 V
R1172H302B	J 3 0 E	3.0 V	R1172H302D	J 3 0 F	3.0 V
R1172H312B	J 3 1 E	3.1 V	R1172H312D	J 3 1 F	3.1 V
R1172H322B	J 3 2 E	3.2 V	R1172H322D	J 3 2 F	3.2 V
R1172H332B	J 3 3 E	3.3 V	R1172H332D	J 3 3 F	3.3 V
R1172H342B	J 3 4 E	3.4 V	R1172H342D	J 3 4 F	3.4 V
R1172H352B	J 3 5 E	3.5 V	R1172H352D	J 3 5 F	3.5 V
R1172H362B	J 3 6 E	3.6 V	R1172H362D	J 3 6 F	3.6 V
R1172H372B	J 3 7 E	3.7 V	R1172H372D	J 3 7 F	3.7 V
R1172H382B	J 3 8 E	3.8 V	R1172H382D	J 3 8 F	3.8 V
R1172H392B	J 3 9 E	3.9 V	R1172H392D	J 3 9 F	3.9 V
R1172H402B	J 4 0 E	4.0 V	R1172H402D	J 4 0 F	4.0 V
R1172H412B	J 4 1 E	4.1 V	R1172H412D	J 4 1 F	4.1 V
R1172H422B	J 4 2 E	4.2 V	R1172H422D	J 4 2 F	4.2 V
R1172H432B	J 4 3 E	4.3 V	R1172H432D	J 4 3 F	4.3 V
R1172H442B	J 4 4 E	4.4 V	R1172H442D	J 4 4 F	4.4 V
R1172H452B	J 4 5 E	4.5 V	R1172H452D	J 4 5 F	4.5 V
R1172H462B	J 4 6 E	4.6 V	R1172H462D	J 4 6 F	4.6 V
R1172H472B	J 4 7 E	4.7 V	R1172H472D	J 4 7 F	4.7 V
R1172H482B	J 4 8 E	4.8 V	R1172H482D	J 4 8 F	4.8 V
R1172H492B	J 4 9 E	4.9 V	R1172H492D	J 4 9 F	4.9 V
R1172H502B	J 5 0 E	5.0 V	R1172H502D	J 5 0 F	5.0 V
R1172H182B5	J 0 1 E	1.85 V	R1172H182D5	J 0 1 F	1.85 V
R1172H282B5	J 0 2 E	2.85 V	R1172H282D5	J 0 2 F	2.85 V
R1172H122B5	J 0 3 E	1.25 V	R1172H122D5	J 0 3 F	1.25 V

POWER DISSIPATION (HSOP-6J)

Power Dissipation (P_D) depends on conditions of mounting on board. This specification is based on the measurement at the condition below:

Measurement Conditions

	Ultra High Wattage Land Pattern	Standard Land Pattern
Environment	Mounting on Board (Wind velocity=0m/s)	Mounting on Board (Wind velocity=0m/s)
Board Material	Glass cloth epoxy plastic (4 Layers)	Glass cloth epoxy plastic (2 Layers)
Board Dimensions	76.2mm × 114.3mm × 0.8mm	50mm × 50mm × 1.6mm
Copper Ratio	96%	50%
Through-hole	φ0.3mm × 28pcs	φ0.5mm × 24pcs

Measurement Result

($T_a=25^{\circ}\text{C}$, $T_{jmax}=125^{\circ}\text{C}$)

	Ultra High Wattage Land Pattern	Standard Land Pattern	Free Air
Power Dissipation	2700mW	1700mW	540mW
Thermal Resistance	37°C/W	59°C/W	185°C/W

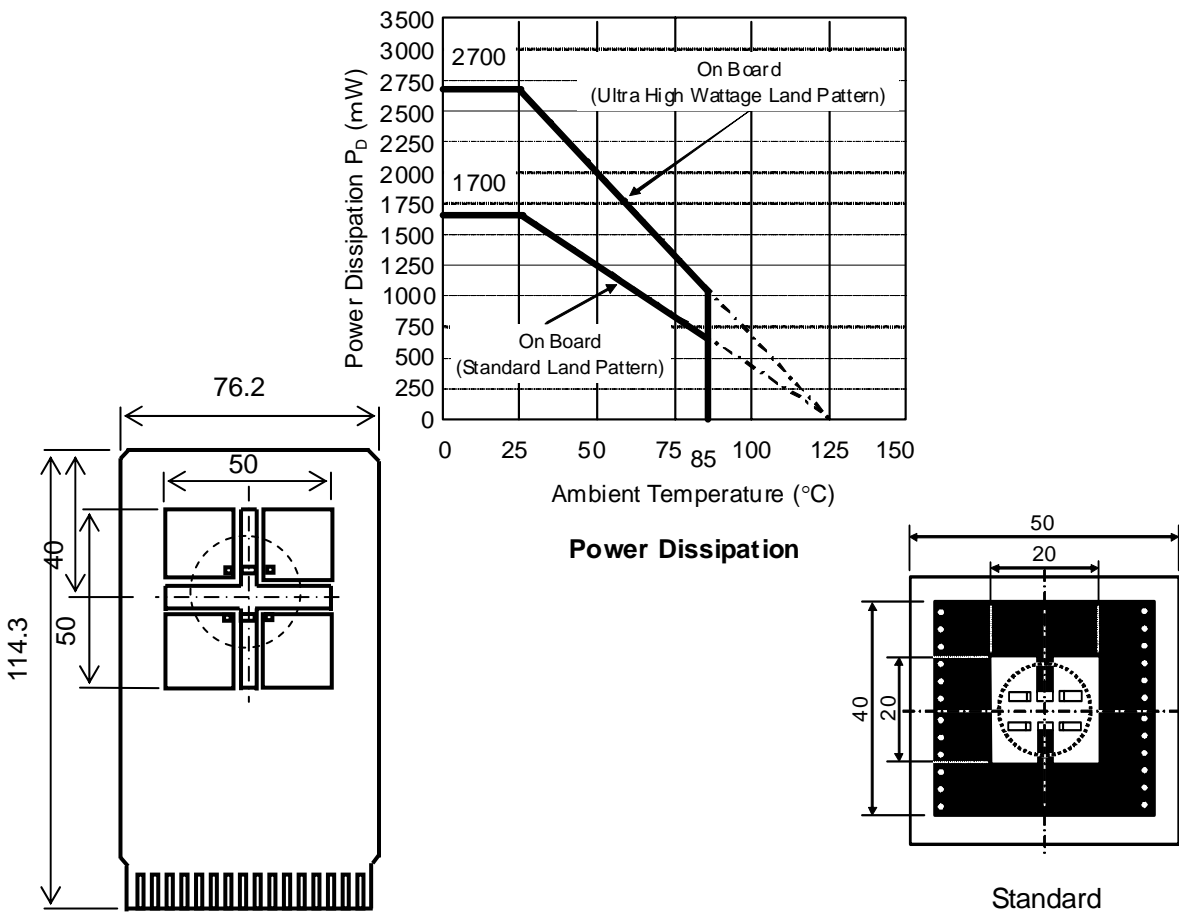

○ Ultra High Wattage Land Pattern
○ IC Mount Area (Unit: mm)

○ Measurement Board Pattern
○ IC Mount Area (Unit: mm)

PACKAGE DIMENSIONS (HSOP-6J)

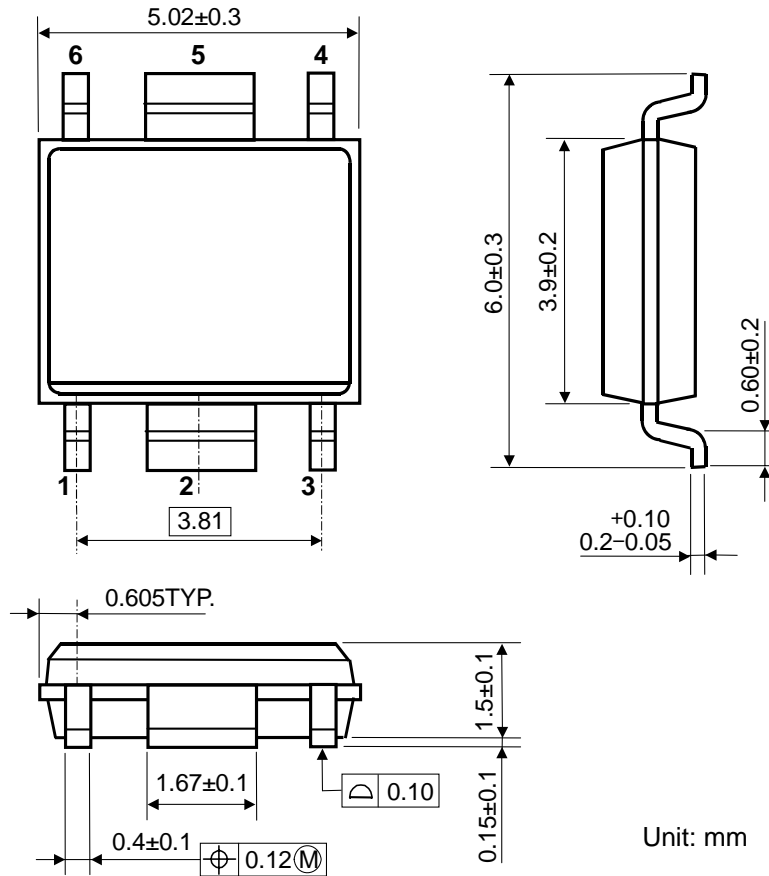

MARK SPECIFICATION (HSOP-6J)

①②③④: Product Code ... Refer to MARK SPECIFICATION TABLE (HSOP-6J)

⑤⑥: Lot Number ... Alphanumeric Serial Number

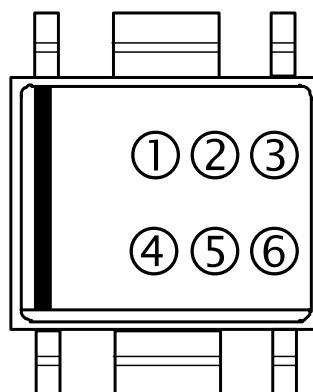

R1172x

NO. EC-128-140219

MARK SPECIFICATION TABLE (HSOP-6J)

Product Name	①②③④	V _{SET}	Product Name	①②③④	V _{SET}
R1172S082B	B 0 8 E	0.8 V	R1172S082D	B 0 8 F	0.8 V
R1172S092B	B 0 9 E	0.9 V	R1172S092D	B 0 9 F	0.9 V
R1172S102B	B 1 0 E	1.0 V	R1172S102D	B 1 0 F	1.0 V
R1172S112B	B 1 1 E	1.1 V	R1172S112D	B 1 1 F	1.1 V
R1172S122B	B 0 6 B	1.2 V	R1172S122D	B 1 2 F	1.2 V
R1172S132B	B 1 3 E	1.3 V	R1172S132D	B 1 3 F	1.3 V
R1172S142B	B 1 4 E	1.4 V	R1172S142D	B 1 4 F	1.4 V
R1172S152B	B 1 5 E	1.5 V	R1172S152D	B 1 5 F	1.5 V
R1172S162B	B 1 6 E	1.6 V	R1172S162D	B 1 6 F	1.6 V
R1172S172B	B 1 7 E	1.7 V	R1172S172D	B 1 7 F	1.7 V
R1172S182B	B 1 8 E	1.8 V	R1172S182D	B 0 5 D	1.8 V
R1172S192B	B 1 9 E	1.9 V	R1172S192D	B 1 9 F	1.9 V
R1172S202B	B 2 0 E	2.0 V	R1172S202D	B 2 0 F	2.0 V
R1172S212B	B 2 1 E	2.1 V	R1172S212D	B 2 1 F	2.1 V
R1172S222B	B 2 2 E	2.2 V	R1172S222D	B 2 2 F	2.2 V
R1172S232B	B 2 3 E	2.3 V	R1172S232D	B 2 3 F	2.3 V
R1172S242B	B 2 4 E	2.4 V	R1172S242D	B 2 4 F	2.4 V
R1172S252B	B 0 4 B	2.5 V	R1172S252D	B 2 5 F	2.5 V
R1172S262B	B 2 6 E	2.6 V	R1172S262D	B 2 6 F	2.6 V
R1172S272B	B 2 7 E	2.7 V	R1172S272D	B 2 7 F	2.7 V
R1172S282B	B 2 8 E	2.8 V	R1172S282D	B 2 8 F	2.8 V
R1172S292B	B 2 9 E	2.9 V	R1172S292D	B 2 9 F	2.9 V
R1172S302B	B 3 0 E	3.0 V	R1172S302D	B 3 0 F	3.0 V
R1172S312B	B 3 1 E	3.1 V	R1172S312D	B 3 1 F	3.1 V
R1172S322B	B 3 2 E	3.2 V	R1172S322D	B 3 2 F	3.2 V
R1172S332B	B 0 5 B	3.3 V	R1172S332D	B 0 4 D	3.3 V
R1172S342B	B 3 4 E	3.4 V	R1172S342D	B 3 4 F	3.4 V
R1172S352B	B 3 5 E	3.5 V	R1172S352D	B 3 5 F	3.5 V
R1172S362B	B 3 6 E	3.6 V	R1172S362D	B 3 6 F	3.6 V
R1172S372B	B 3 7 E	3.7 V	R1172S372D	B 3 7 F	3.7 V
R1172S382B	B 3 8 E	3.8 V	R1172S382D	B 3 8 F	3.8 V
R1172S392B	B 3 9 E	3.9 V	R1172S392D	B 3 9 F	3.9 V
R1172S402B	B 4 0 E	4.0 V	R1172S402D	B 4 0 F	4.0 V
R1172S412B	B 4 1 E	4.1 V	R1172S412D	B 4 1 F	4.1 V
R1172S422B	B 4 2 E	4.2 V	R1172S422D	B 4 2 F	4.2 V
R1172S432B	B 4 3 E	4.3 V	R1172S432D	B 4 3 F	4.3 V
R1172S442B	B 4 4 E	4.4 V	R1172S442D	B 4 4 F	4.4 V
R1172S452B	B 4 5 E	4.5 V	R1172S452D	B 4 5 F	4.5 V
R1172S462B	B 4 6 E	4.6 V	R1172S462D	B 4 6 F	4.6 V
R1172S472B	B 4 7 E	4.7 V	R1172S472D	B 4 7 F	4.7 V
R1172S482B	B 4 8 E	4.8 V	R1172S482D	B 4 8 F	4.8 V
R1172S492B	B 4 9 E	4.9 V	R1172S492D	B 4 9 F	4.9 V
R1172S502B	B 5 0 E	5.0 V	R1172S502D	B 5 0 F	5.0 V
R1172S182B5	B 0 1 E	1.85 V	R1172S182D5	B 0 1 F	1.85 V
R1172S282B5	B 0 2 E	2.85 V	R1172S282D5	B 0 2 F	2.85 V
R1172S122B5	B 0 3 E	1.25 V	R1172S122D5	B 0 3 F	1.25 V

TYPICAL CHARACTERISTICS

Note: Typical Characteristics are intended to be used as reference data; they are not guaranteed.

1) Output Voltage vs. Output Current ($T_a=25^\circ\text{C}$)

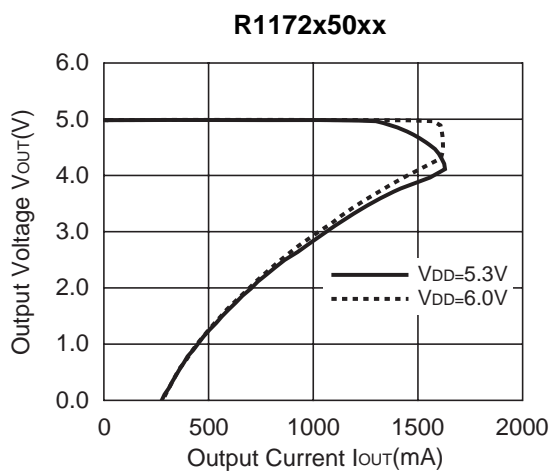
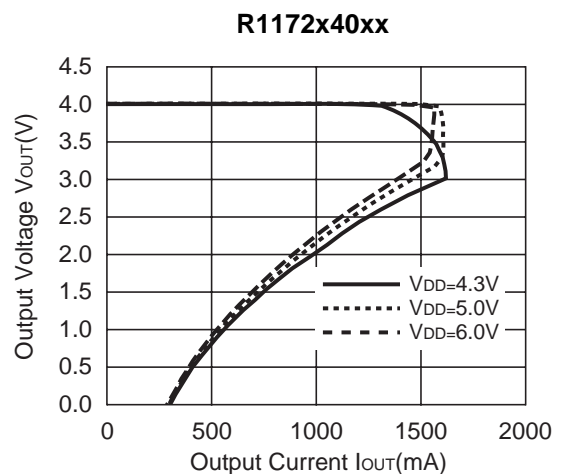
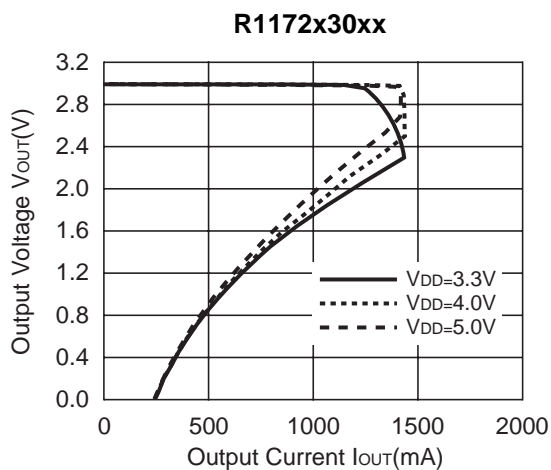
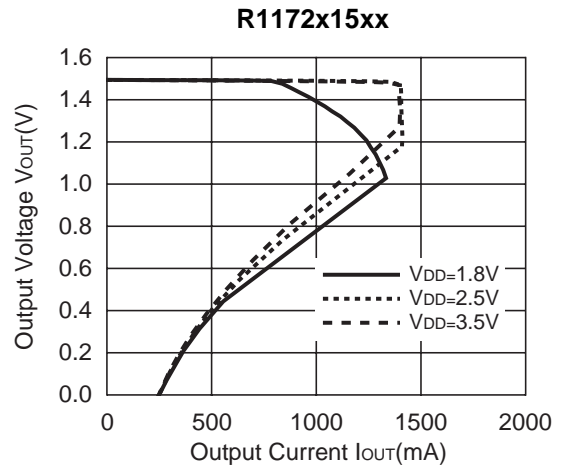
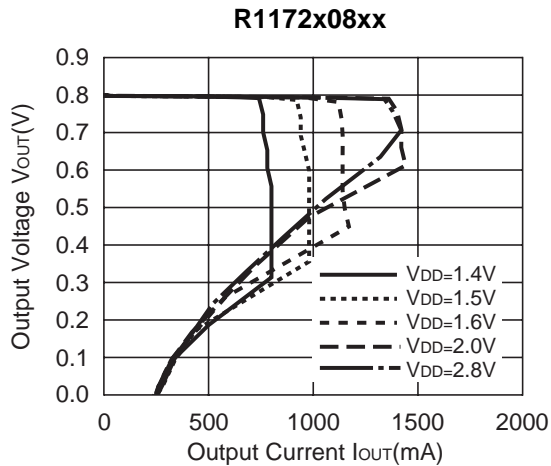

R1172x

NO. EC-128-140219

2) Output Voltage vs. Input Voltage (Ta=25°C)

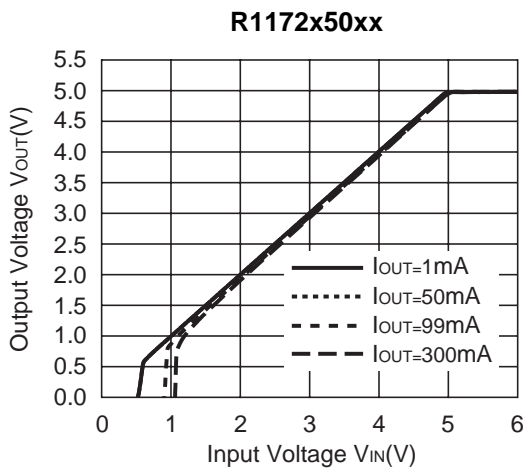
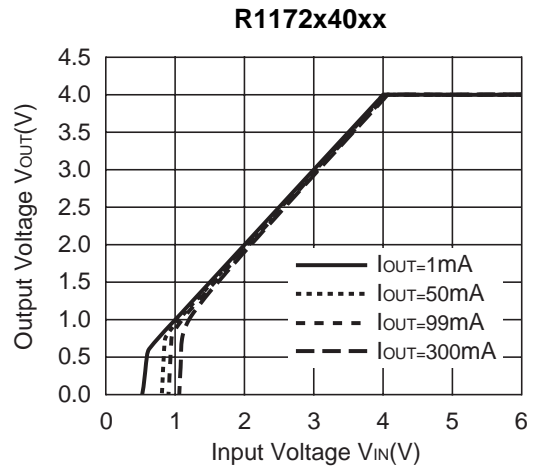
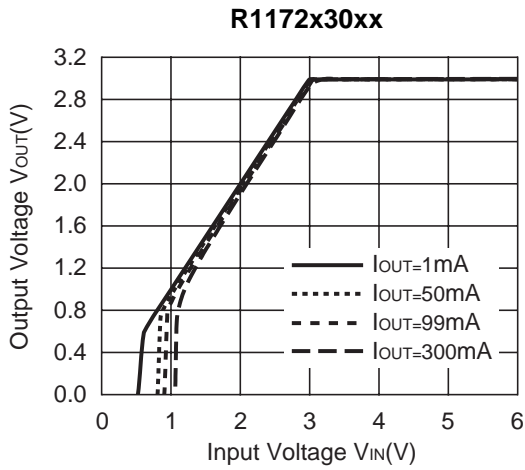
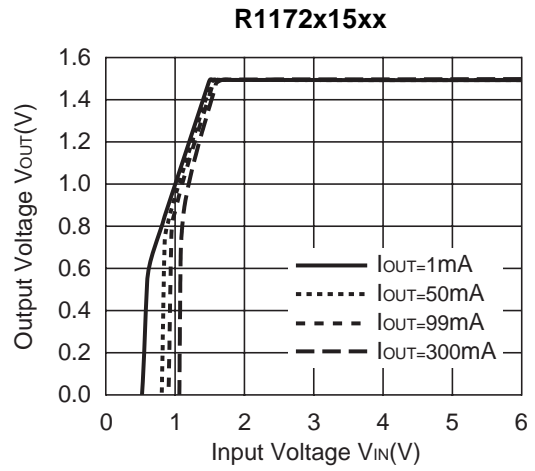
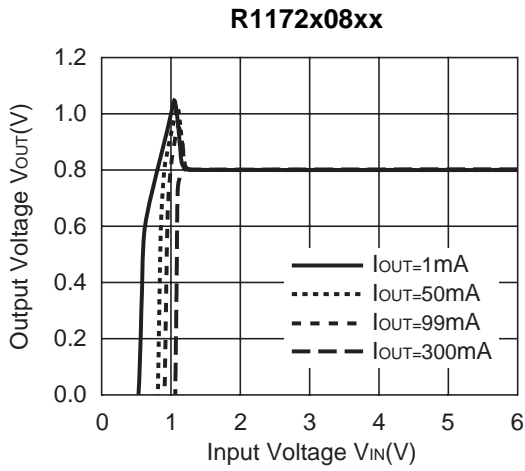

3) Supply Current vs. Input Current (Ta=25°C)

R1172x08xx

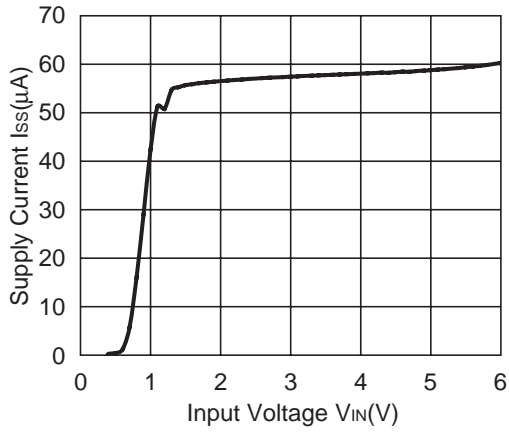

R1172x15xx

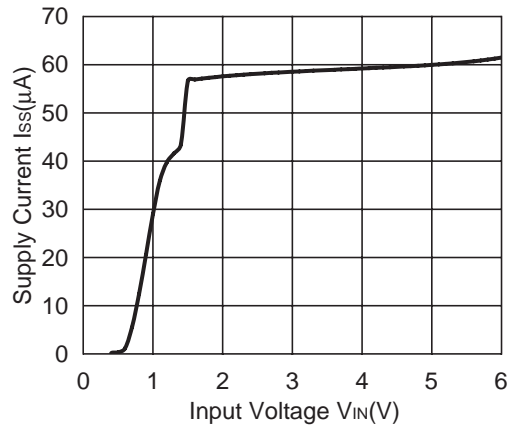

R1172x30xx

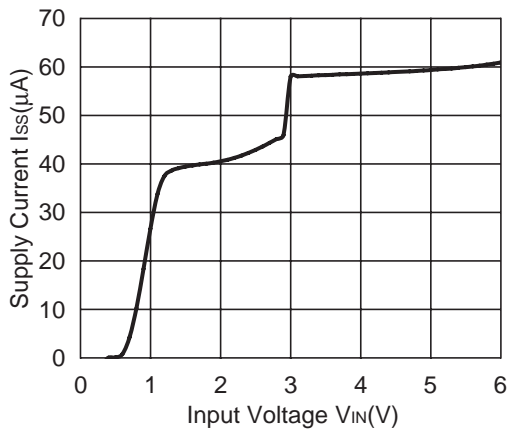

R1172x40xx

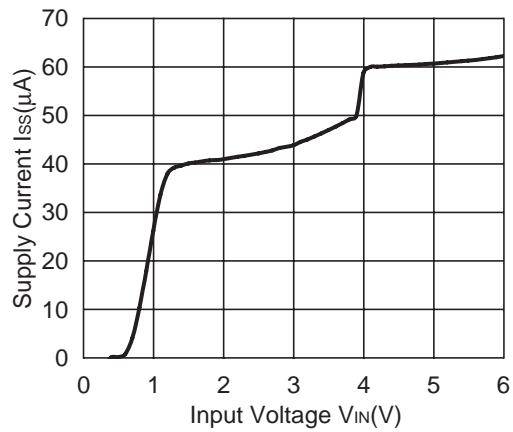

R1172x50xx

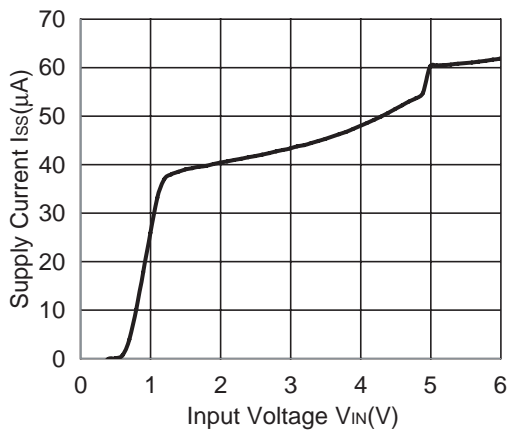

R1172xNO. EC-128-140219

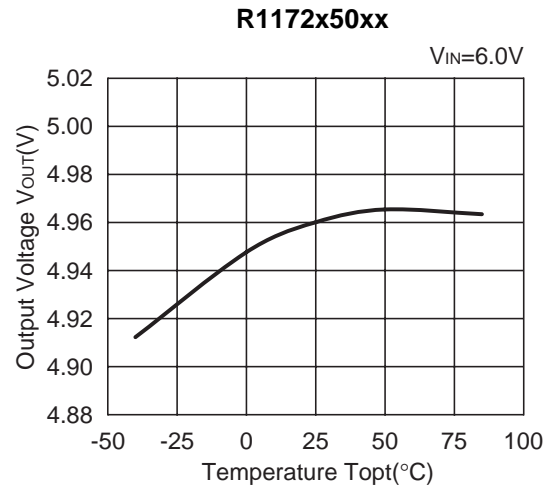
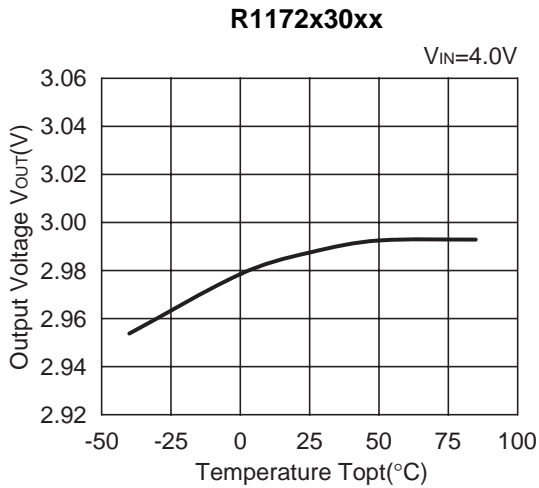
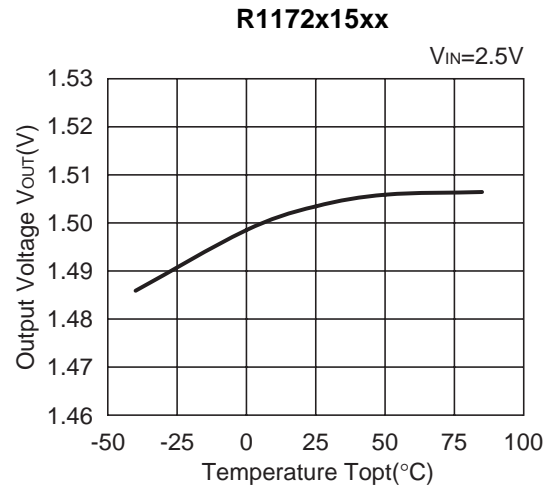
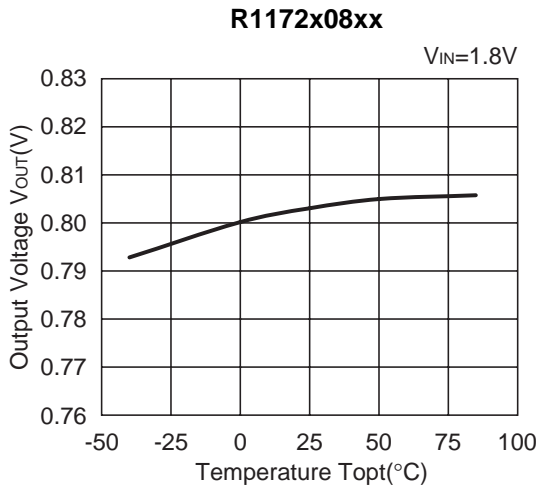
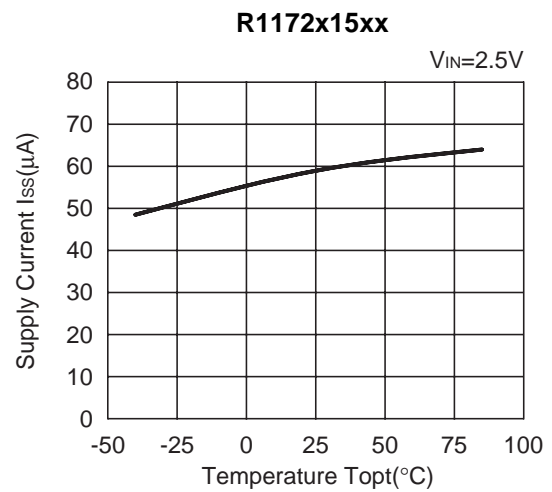
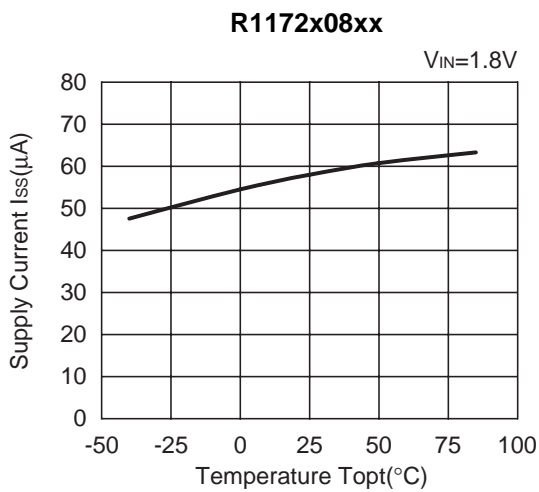
4) Output Voltage vs. Temperature (I_{OUT}=100mA)**5) Supply Current vs. Temperature**

R1172x30xx

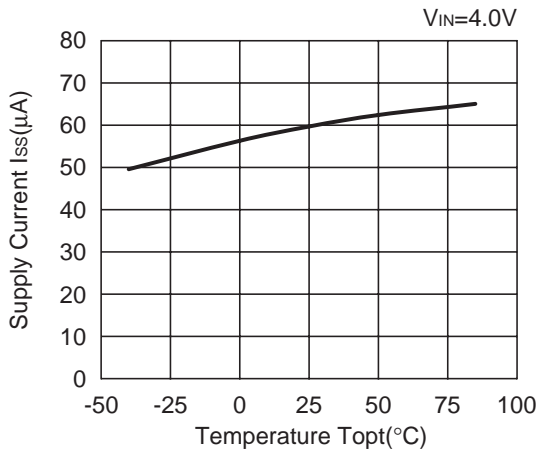

R1172x50xx

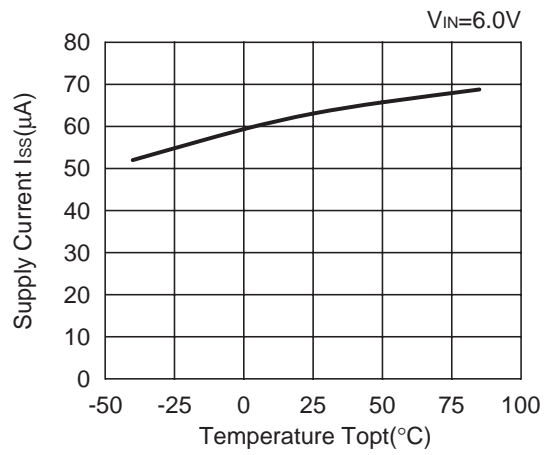

6) Dropout Voltage vs. Output Current

R1172x08xx

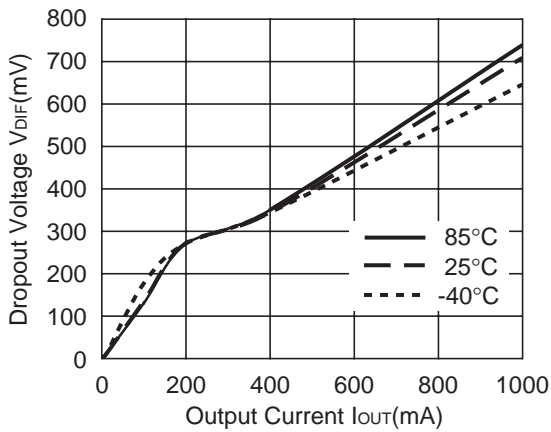

R1172x09xx

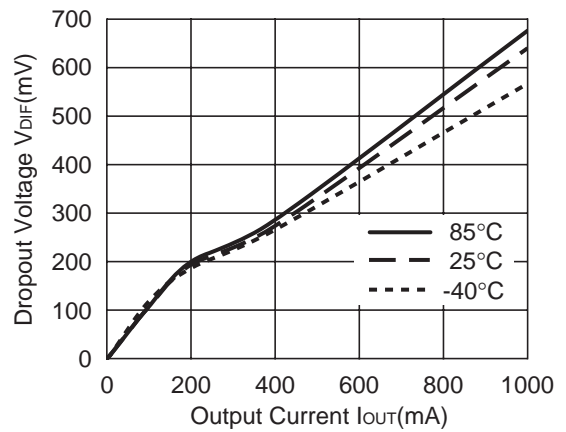

R1172x10xx

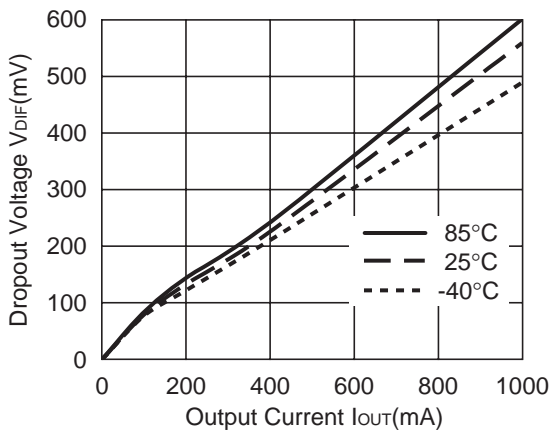

R1172x15xx

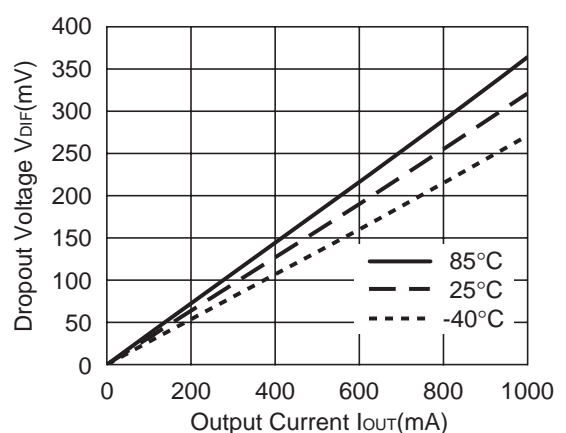

R1172x

NO. EC-128-140219

R1172x30xx

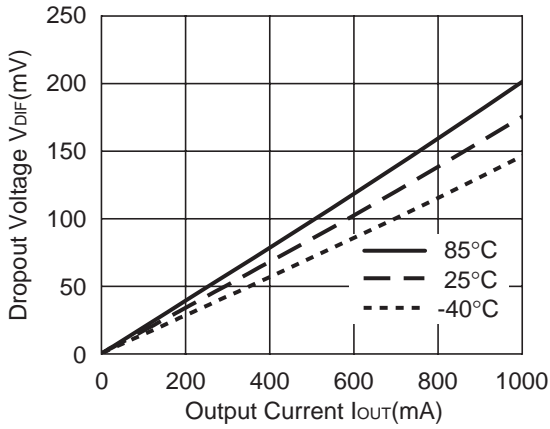

R1172x50xx

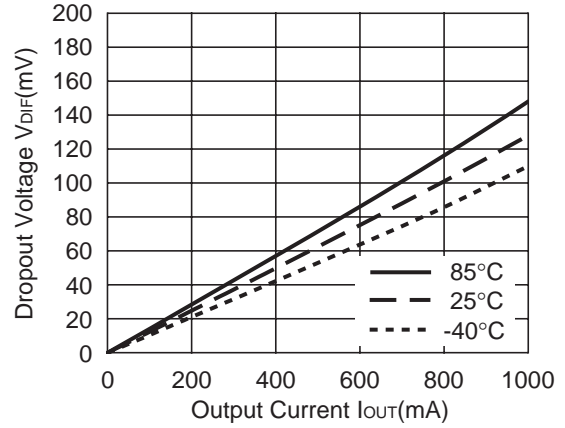

7) Dropout Voltage vs. Set Output Voltage

R1172xxxxx

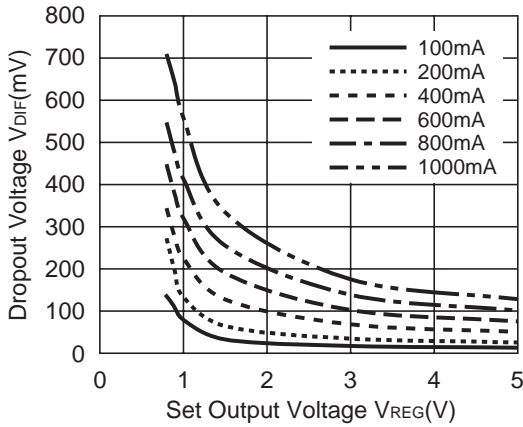

8) 0.8V Output type, Operating Input Voltage Range

R1172x08xx

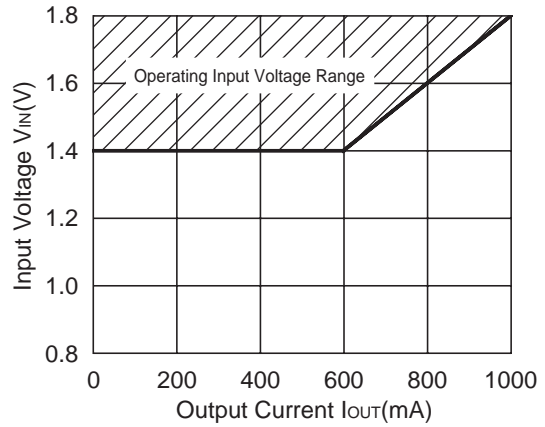

9) Ripple Rejection vs. Input Bias

R1172x30xx

$V_{IN}=4.0V_{DC}+0.2V_{p-p}, I_{OUT}=1mA$

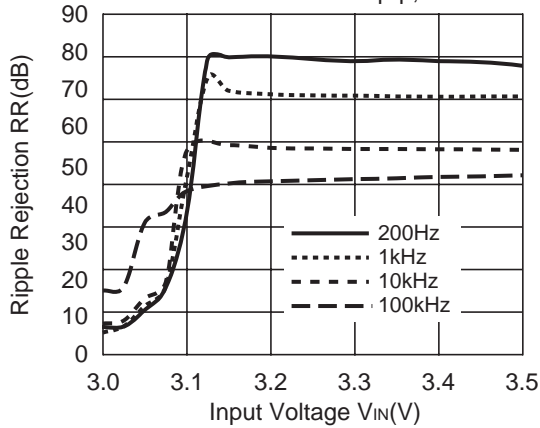

R1172x30xx

$V_{IN}=4.0V_{DC}+0.5V_{p-p}, I_{OUT}=1mA$

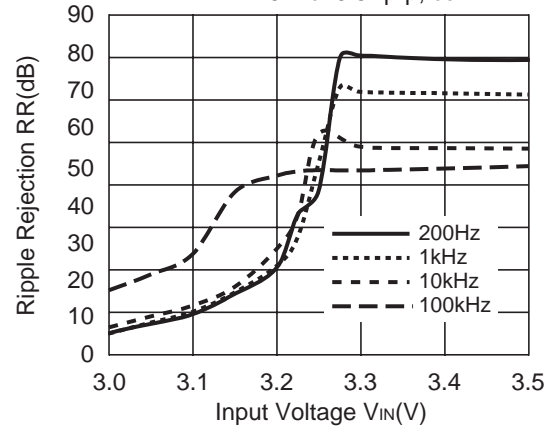

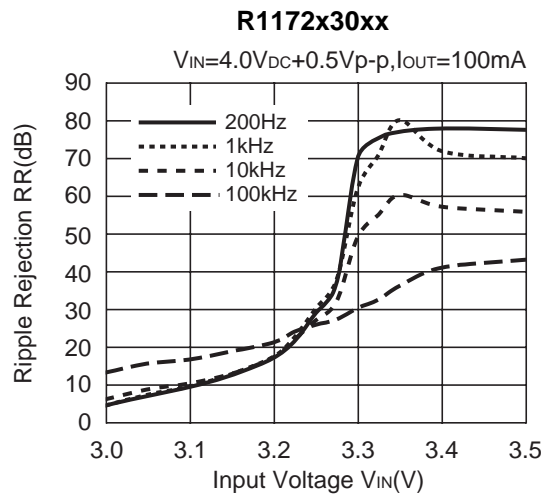
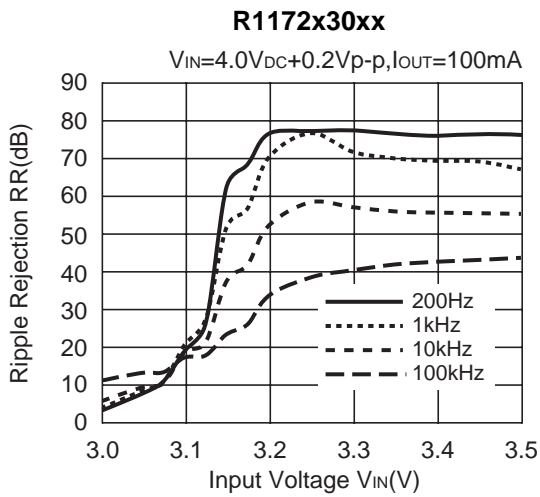
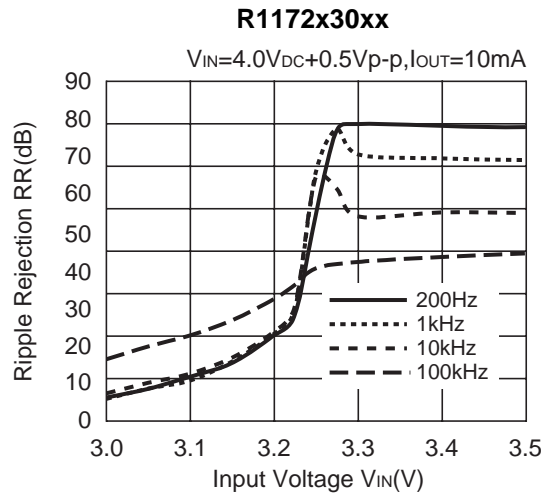
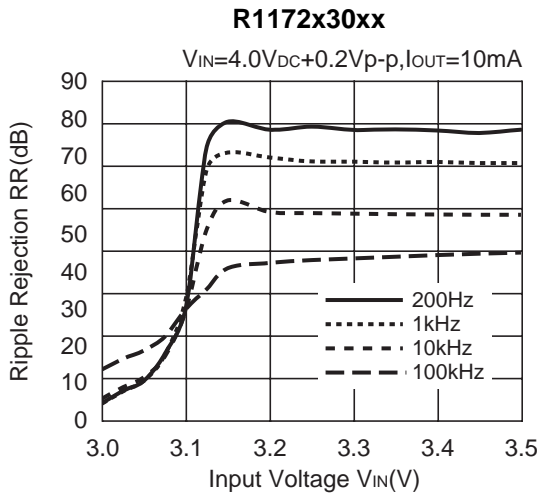

10) Ripple Rejection vs. Frequency

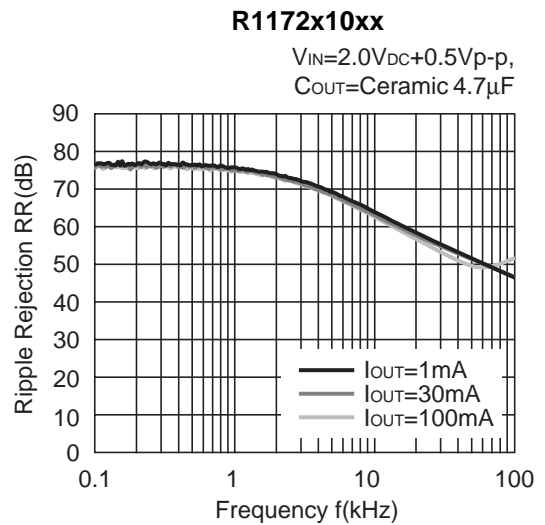
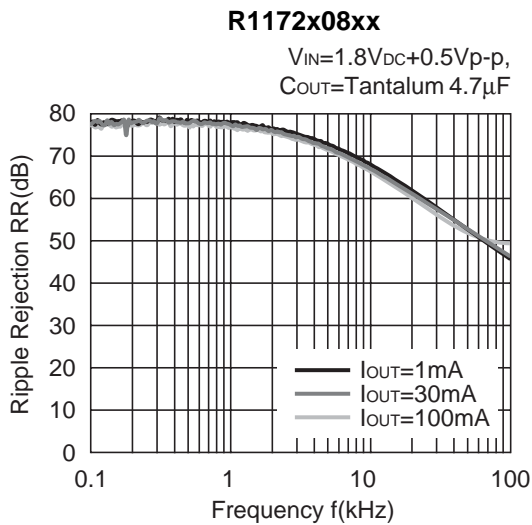

R1172x

NO. EC-128-140219

R1172x30xx

$V_{IN}=4.0V_{DC}+0.5V_{p-p}$,
 $C_{OUT}=\text{Ceramic } 4.7\mu F$

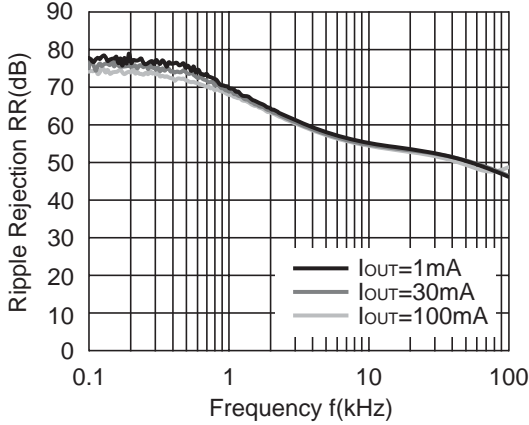

R1172x40xx

$V_{IN}=5.0V_{DC}+0.5V_{p-p}$,
 $C_{OUT}=\text{Ceramic } 4.7\mu F$

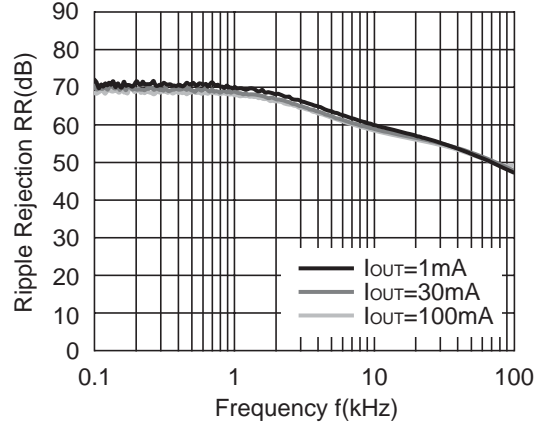

R1172x45xx

$V_{IN}=5.5V_{DC}+0.5V_{p-p}$,
 $C_{OUT}=\text{Ceramic } 4.7\mu F$

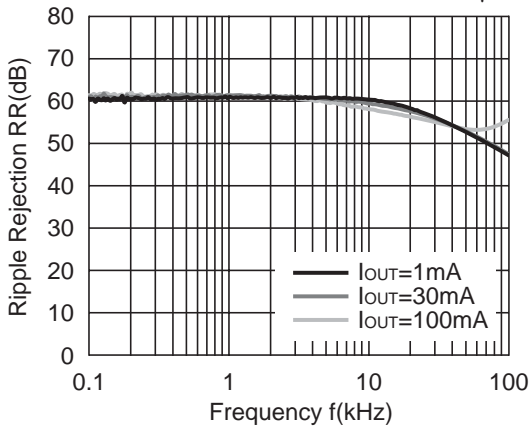

R1172x50xx

$V_{IN}=6.0V_{DC}+0.5V_{p-p}$,
 $C_{OUT}=\text{Ceramic } 4.7\mu F$

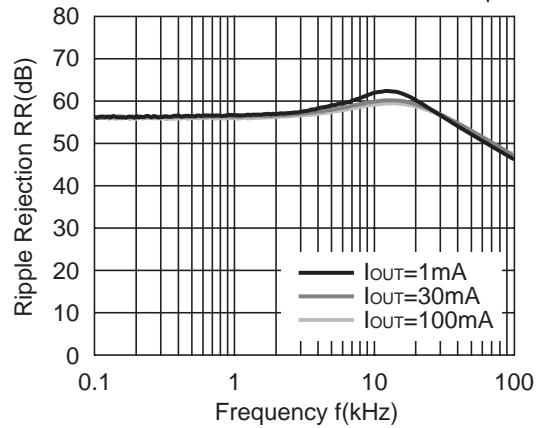

11) Line Transient Response ($t_r=t_f=5\mu s$, $I_{OUT}=100mA$)

R1172x08xx

$C_{OUT}=\text{Tantalum } 4.7\mu F$

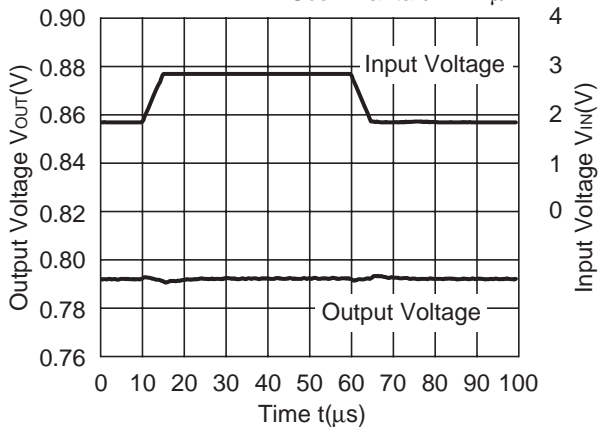

R1172x10xx

$C_{OUT}=\text{Ceramic } 4.7\mu F$

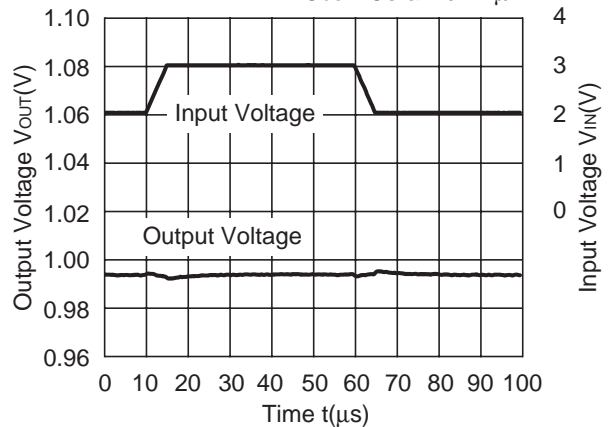

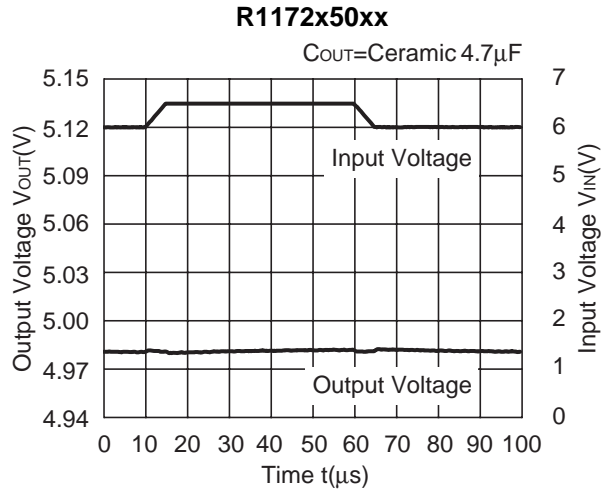
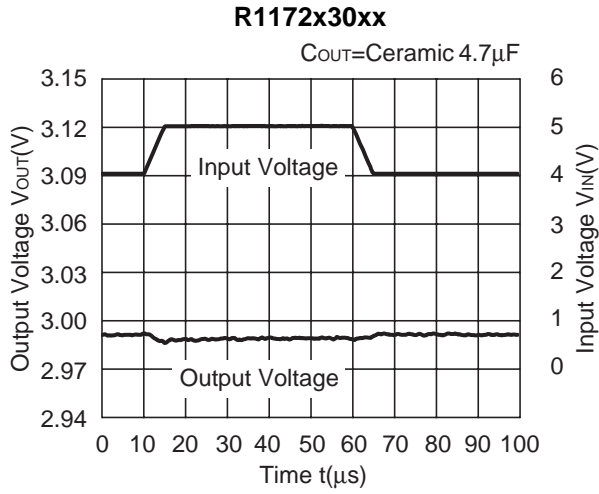

12) Load Transient Response (tr=tf=500ns)

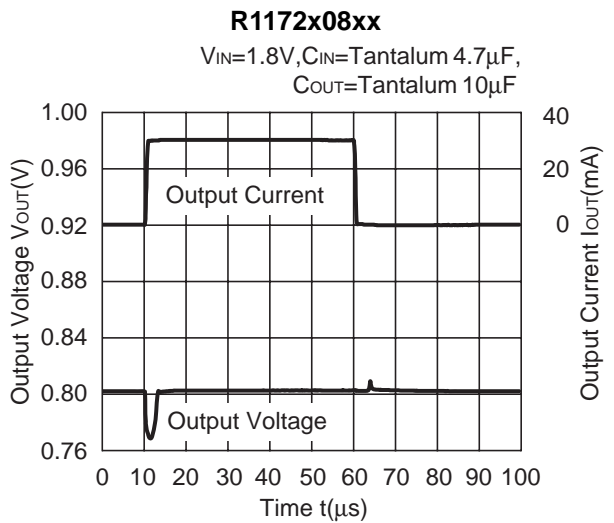
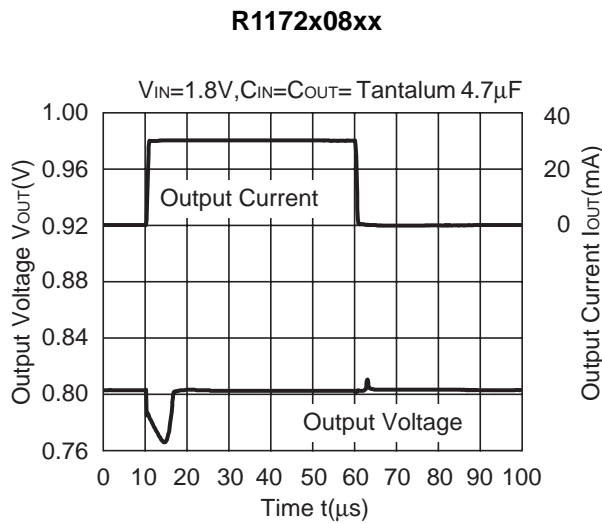
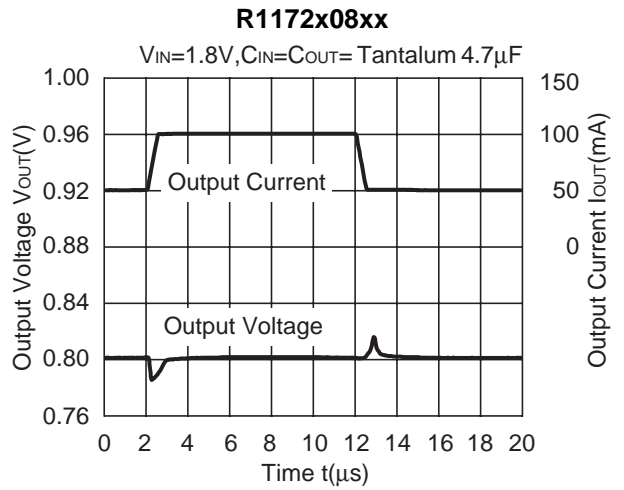
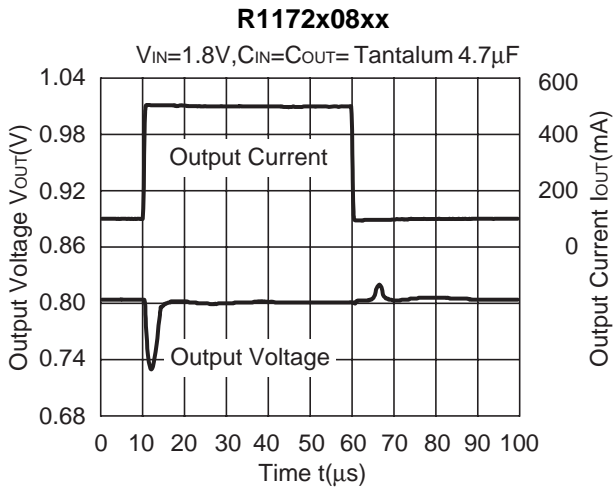

R1172x

NO. EC-128-140219

R1172x10xx

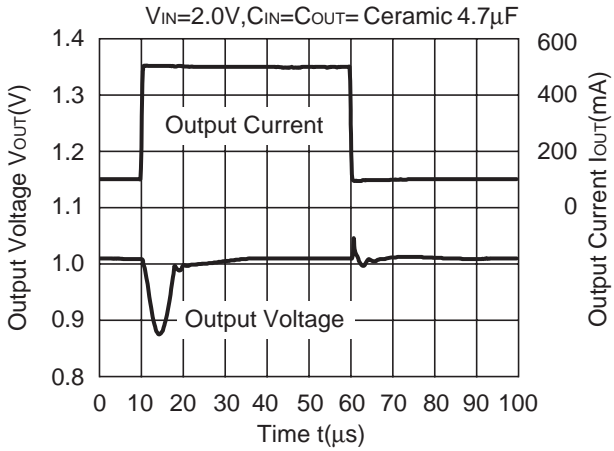

R1172x10xx

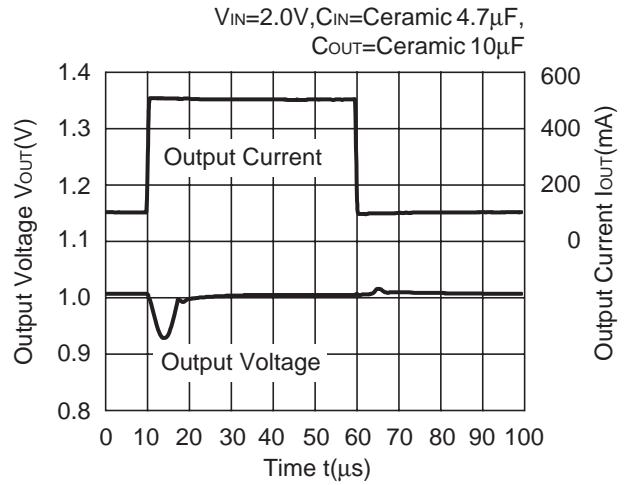

R1172x10xx

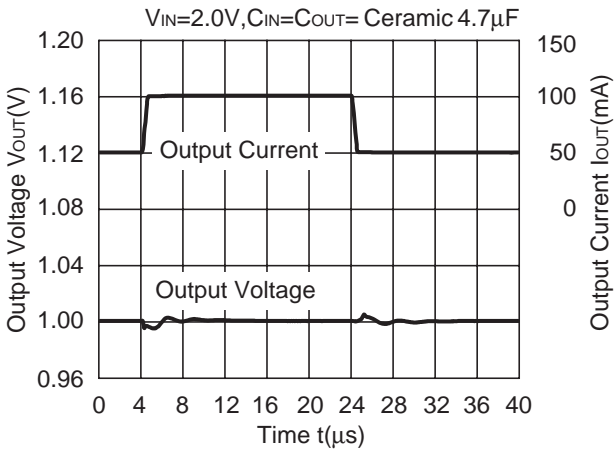

R1172x10xx

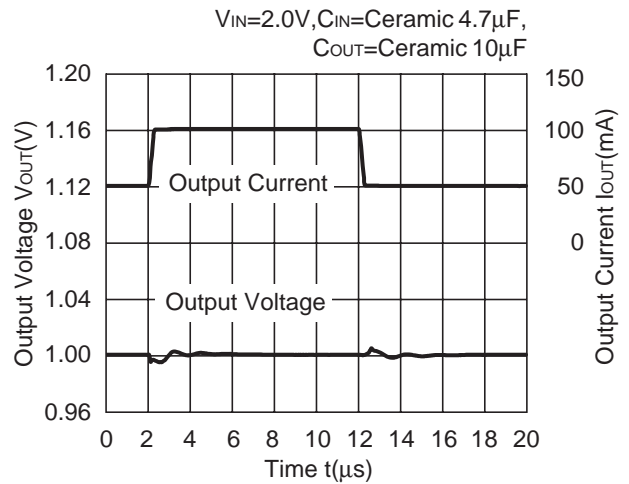

R1172x10xx

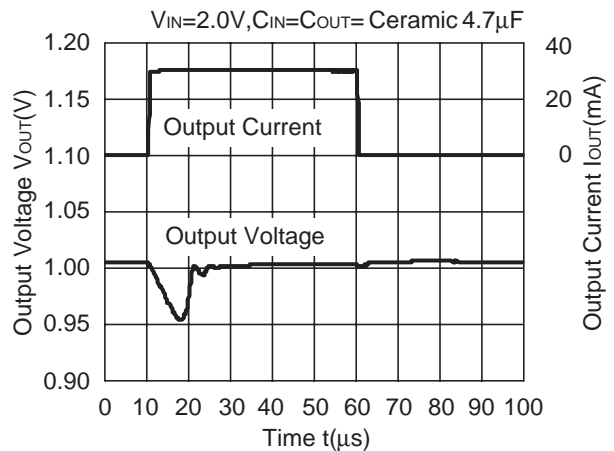

R1172x10xx

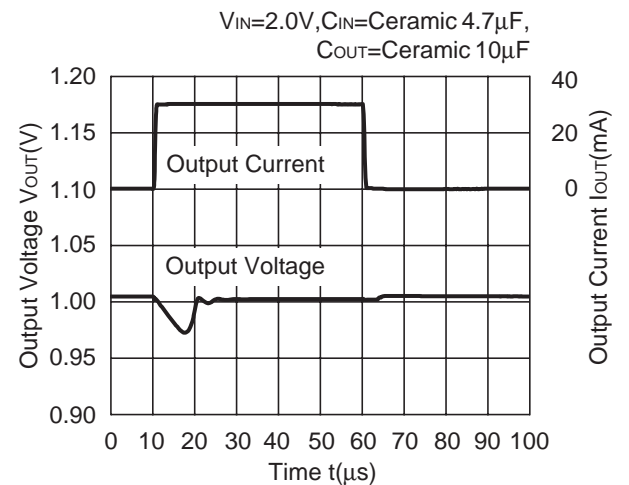

R1172x30xx

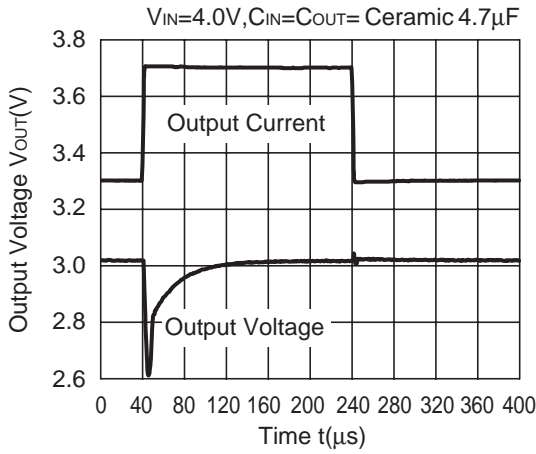

R1172x30xx

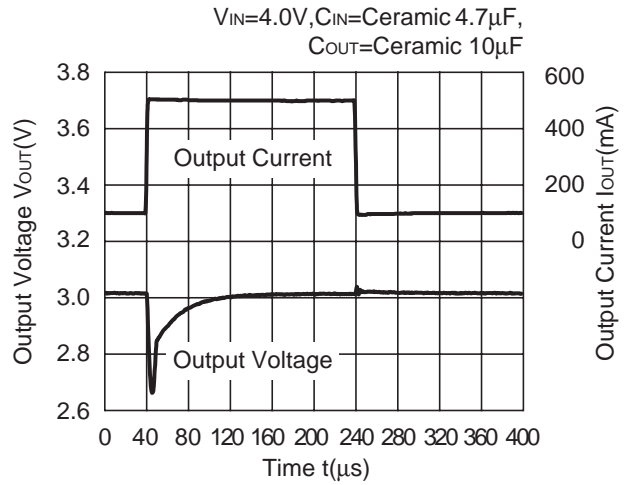

R1172x30xx

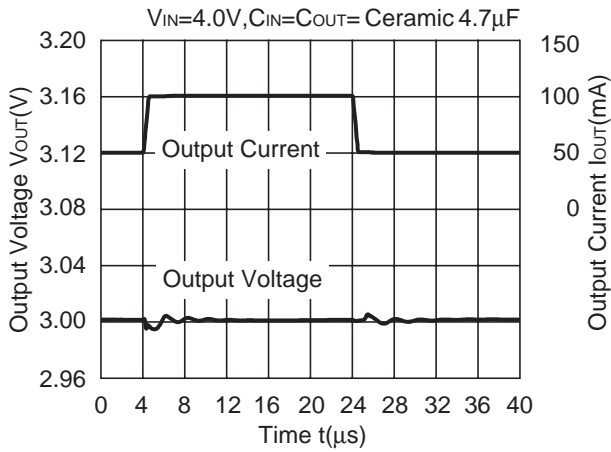

R1172x30xx

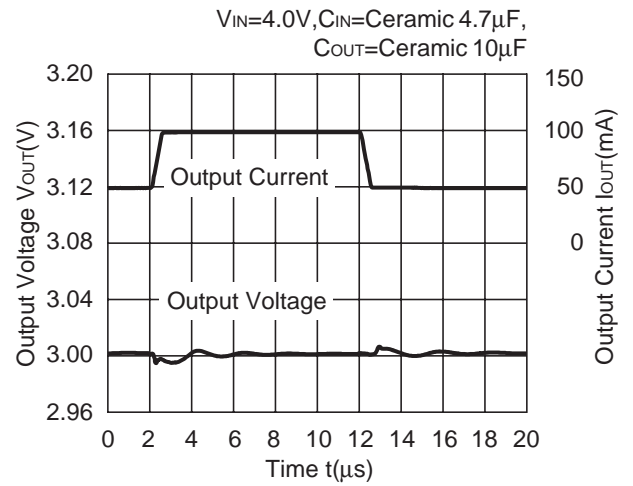

R1172x30xx

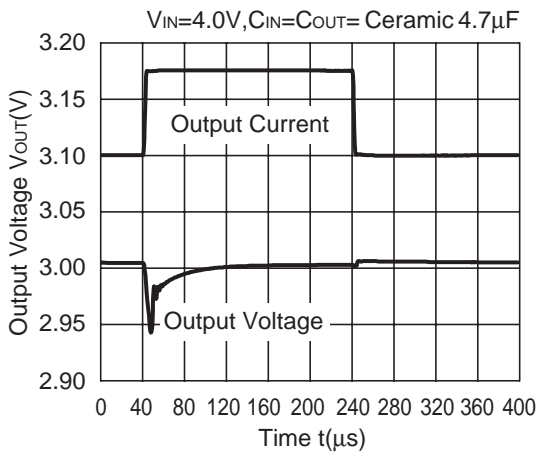

R1172x30xx

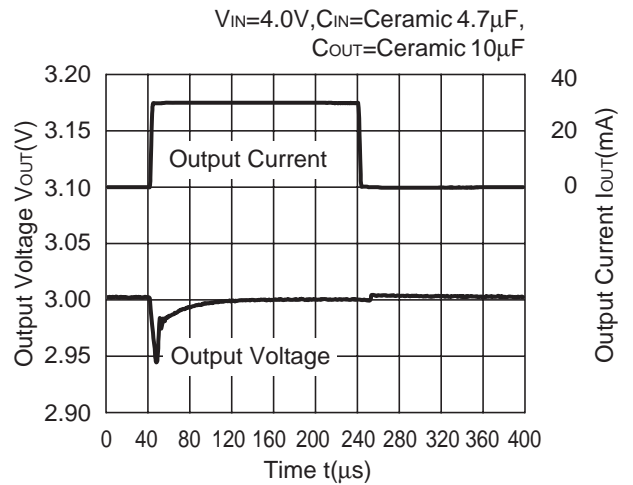

R1172x

NO. EC-128-140219

R1172x50xx

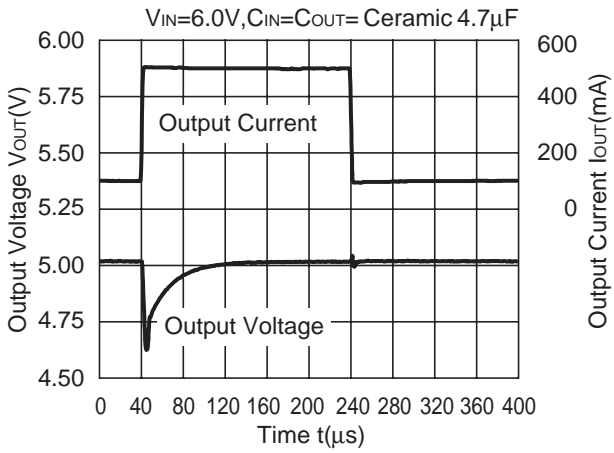

R1172x50xx

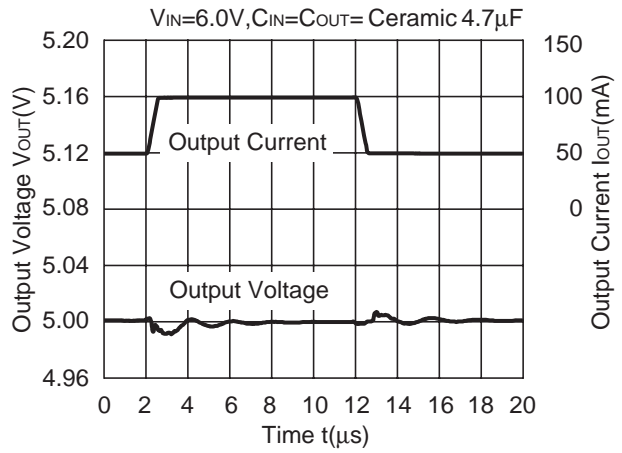

R1172x50xx

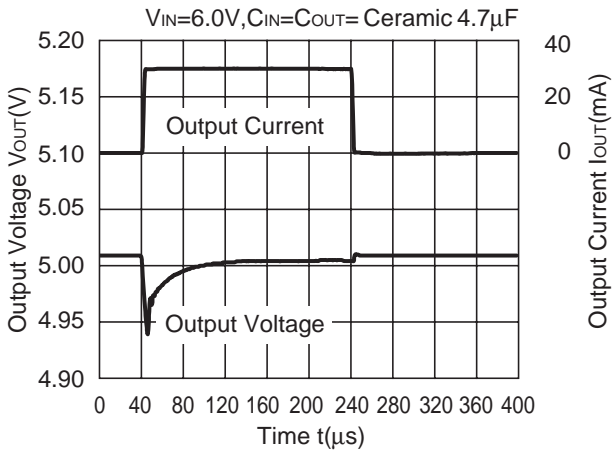

13) Turn-on speed with CE pin control

R1172x08xx

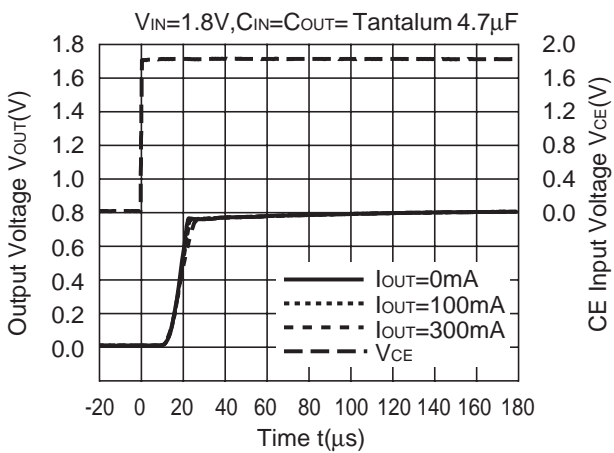

R1172x50xx

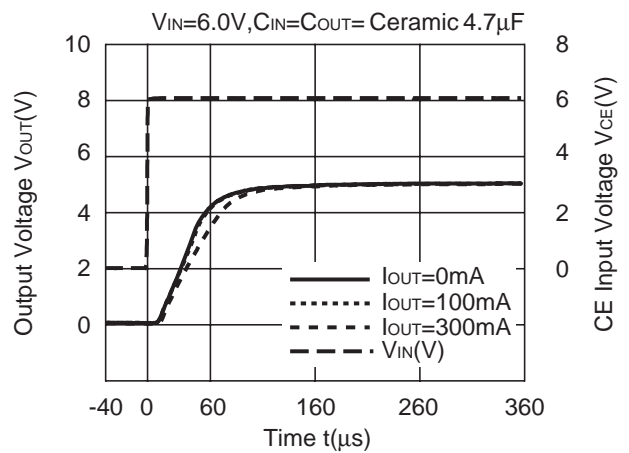

14) Turn-off speed with CE pin control

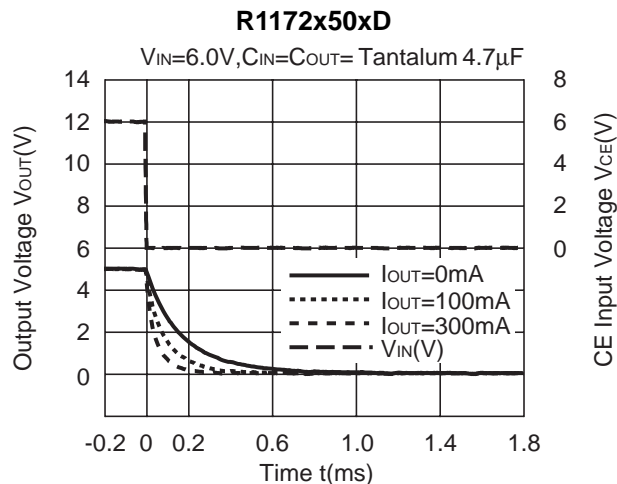
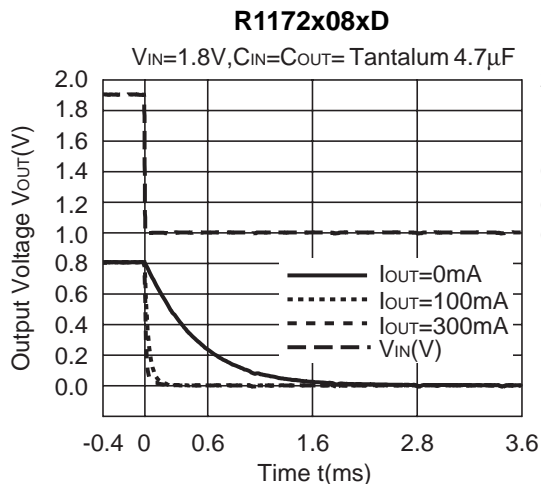

15) Inrush Current ($I_{out}=100mA, C_{in}=none$)

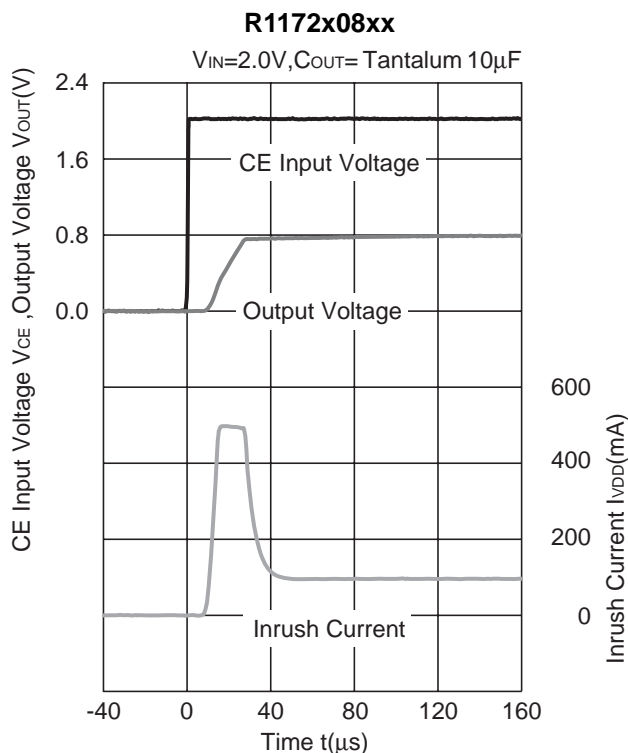
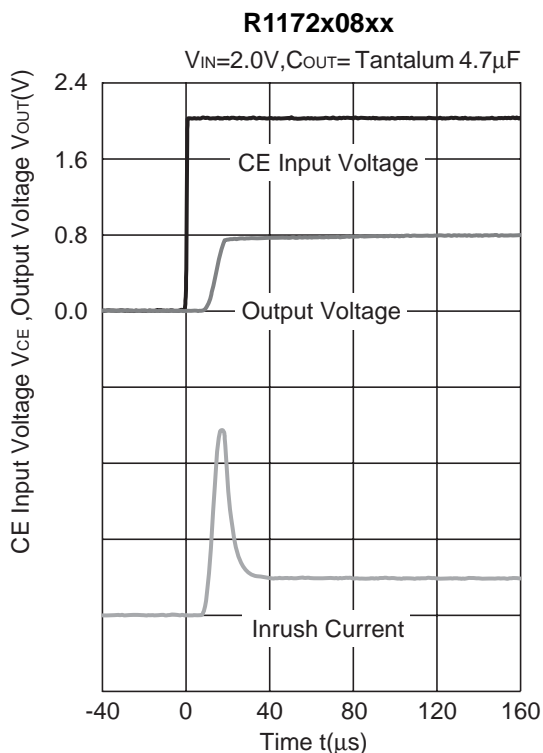

R1172x30xx

V_{IN}=4.0V, C_{OUT}= Ceramic 4.7μF

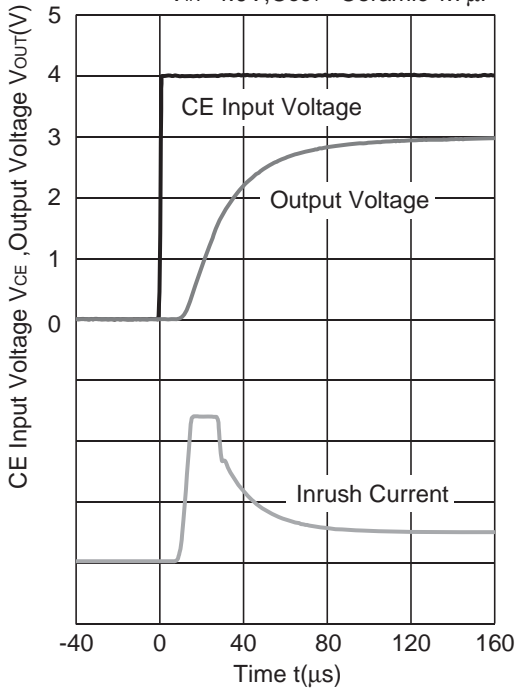

R1172x30xx

V_{IN}=4.0V, C_{OUT}= Ceramic 10μF

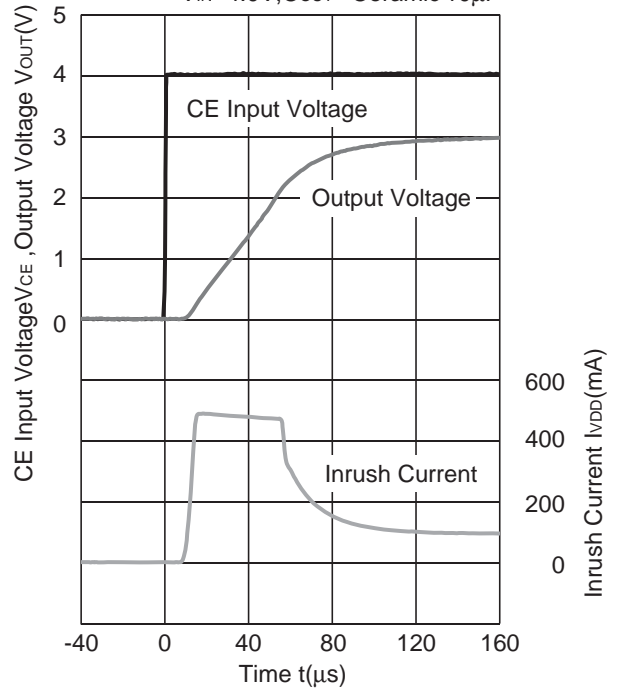

R1172x50xx

V_{IN}=6.0V, C_{OUT}= Ceramic 4.7μF

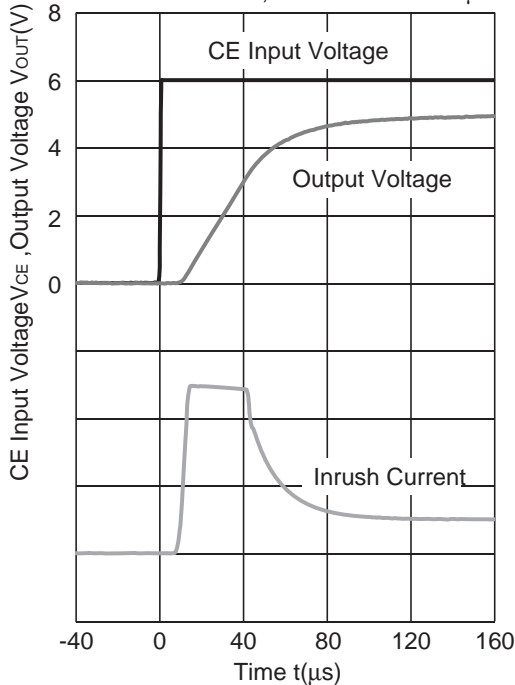

R1172x50xx

V_{IN}=6.0V, C_{OUT}= Ceramic 10μF

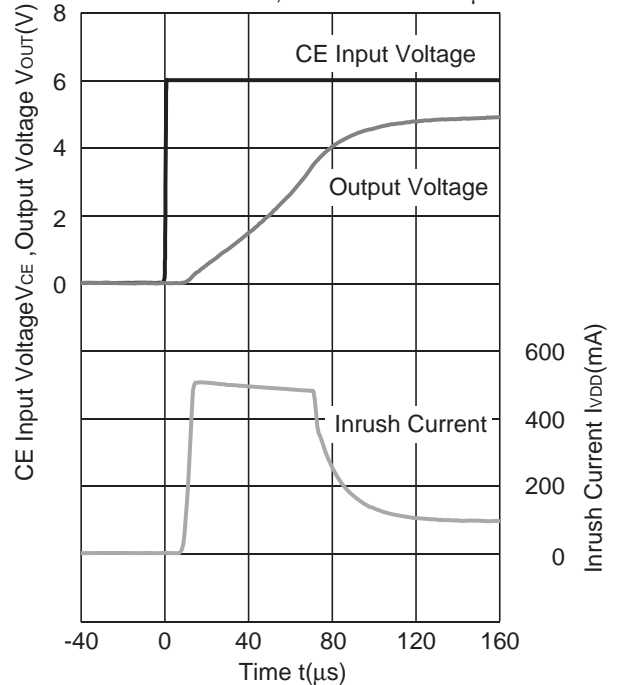

ESR vs. OUTPUT CURRENT

When using these ICs, consider the following points:

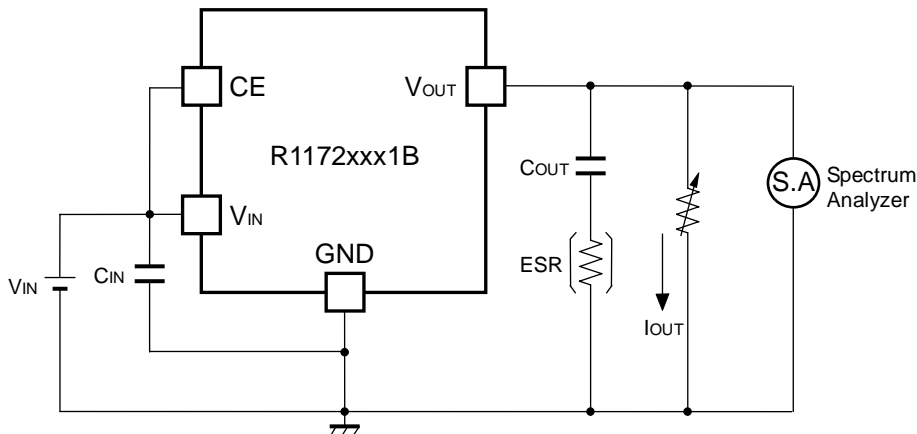

0.8V to 3.3V Output type: $C_{OUT}=4.7\mu\text{F}$ (Kyocera CM105X5R475M06AB)

5.0V Output type : $C_{OUT}=4.7\mu\text{F}$ (Kyocera CT21X5R475K06AB)

As an output capacitor for this IC, Ceramic capacitor is recommendable. However, other low ESR type capacitor can be used with this IC.

For your reference, noise level is tested, and if the noise level is $40\mu\text{V}$ or less than $40\mu\text{V}$, the ESR values are plotted as stable area. Upper limit is described in the next five graphs, or ESR vs. Output Current. (Hatched area is the stable area).

Measurement conditions

- $V_{IN}=V_{OUT}+1\text{V}$
- Frequency Band: 10Hz to 1MHz
- Temperature : 25°C
- Hatched area: Noise level is less than or equal to $40\mu\text{V}$ (average).

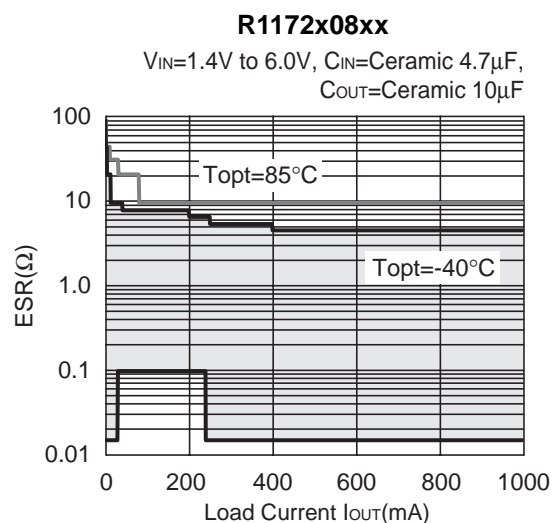
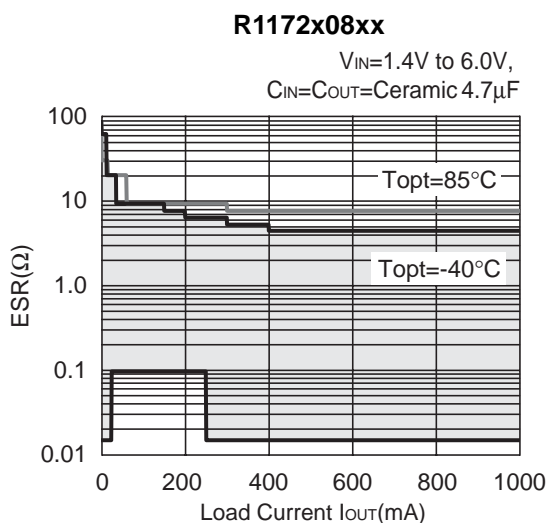

R1172xNO. EC-128-140219

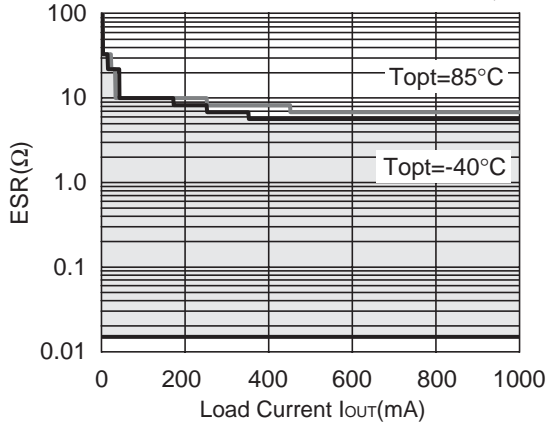
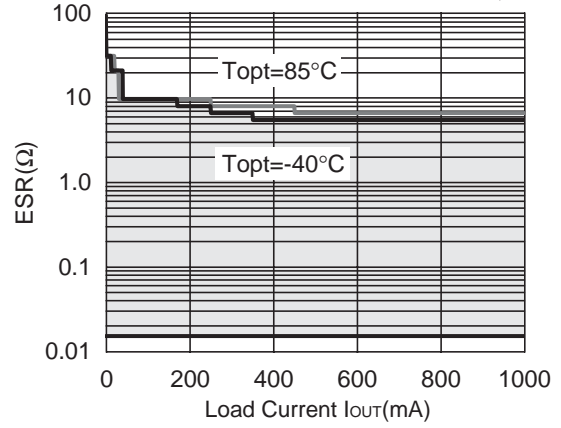
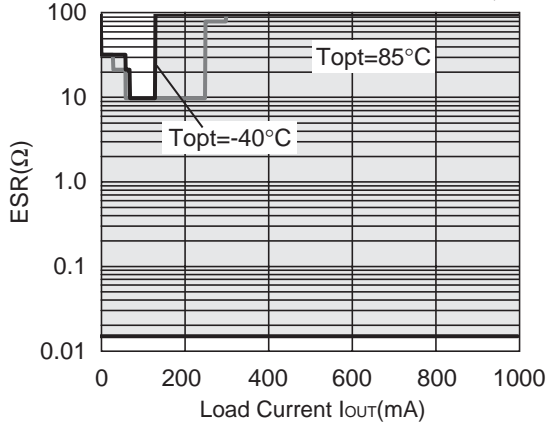
R1172x10xx $V_{IN}=1.4V$ to $6.0V$,
 $C_{IN}=C_{OUT}=\text{Ceramic } 4.7\mu F$ **R1172x30xx** $V_{IN}=3.1V$ to $6.0V$,
 $C_{IN}=C_{OUT}=\text{Ceramic } 4.7\mu F$ **R1172x50xx** $V_{IN}=5.3V$ to $6.0V$,
 $C_{IN}=C_{OUT}=\text{Ceramic } 4.7\mu F$ 



1. The products and the product specifications described in this document are subject to change or discontinuation of production without notice for reasons such as improvement. Therefore, before deciding to use the products, please refer to our sales representatives for the latest information thereon.
2. The materials in this document may not be copied or otherwise reproduced in whole or in part without prior written consent of our company.
3. Please be sure to take any necessary formalities under relevant laws or regulations before exporting or otherwise taking out of your country the products or the technical information described herein.
4. The technical information described in this document shows typical characteristics of and example application circuits for the products. The release of such information is not to be construed as a warranty of or a grant of license under our company's or any third party's intellectual property rights or any other rights.
5. The products in this document are designed for automotive applications. However, when using the products for automotive applications, please make sure to contact our sales representative in advance due to confirming the quality level.
6. We are making our continuous effort to improve the quality and reliability of our products, but semiconductor products are likely to fail with certain probability. In order to prevent any injury to persons or damages to property resulting from such failure, customers should be careful enough to incorporate safety measures in their design, such as redundancy feature, fire containment feature and fail-safe feature. We do not assume any liability or responsibility for any loss or damage arising from misuse or inappropriate use of the products.
7. Anti-radiation design is not implemented in the products described in this document.
8. The X-ray exposure can influence functions and characteristics of the products. Confirm the product functions and characteristics in the evaluation stage.
9. WLCSP products should be used in light shielded environments. The light exposure can influence functions and characteristics of the products under operation or storage.
10. There can be variation in the marking when different AOI (Automated Optical Inspection) equipment is used. In the case of recognizing the marking characteristic with AOI, please contact our sales or our distributor before attempting to use AOI.
11. Please contact our sales representatives should you have any questions or comments concerning the products or the technical information.



Nisshinbo Micro Devices Inc.

Official website

<https://www.nisshinbo-microdevices.co.jp/en/>

Purchase information

<https://www.nisshinbo-microdevices.co.jp/en/buy/>

