

DESCRIPTION

BL8079G series is a group of positive voltage output, low power consumption, low dropout voltage regulator.

BL8079G can provide output value adjustable from 0.8V to 5.0V.

BL8079G includes high accuracy voltage reference, error amplifier, current limit circuit and output driver module with discharge capability.

BL8079G has excellent load and line transient response and good temperature characteristics, which can assure the stability of chip and power system. It uses trimming technique to guarantee output voltage accuracy within $\pm 2\%$. And it also provides fold back short-circuit protection, thermal shutdown and output current limit function.

BL8079G is available in SOT23-5 package which is lead free.

FEATURES

- Low power consumption: 65uA (Typ.)
- Maximum output current: 300mA
- Low dropout voltage:
170mV@ $I_{OUT}=300mA$, $V_{OUT}=3.3V$
- Build-in chip enable and discharge circuit
- Input voltage range: 2~6V
- Adjustable output from 0.8V to 5.0V
- Output voltage accuracy: $\pm 2\%$
- Output current limit
- Short circuit protection
- Over temperature protection

APPLICATIONS

- Power source for cellular phones and various kind of PCSs
- Battery powered equipment
- Power management of MP3, PDA, DSC, Mouse, PS2 games
- Reference voltage source
- Regulation after switching power

TYPICAL APPLICATION

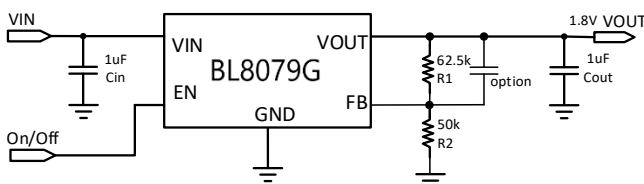

Note:

1) $V_{OUT}=V_{FB}*(1+\frac{R1}{R2})$, $V_{FB}=0.8V$

PIN OUT & MARKING

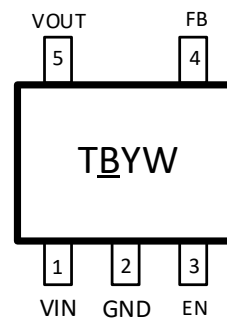

SOT23-5

TB: Product code

YW: Date code (Year & Week)

ORDERING INFORMATION

Part No.	Package	Tape&Reel
BL8079GCB5TR	SOT23-5	3000pcs/reel

ABSOLUTE MAXIMUM RATING

Parameter	Value
Max input voltage	8V
Operating junction temperature(T _J)	150°C
Ambient temperature(T _A)	-40°C –85°C
Power dissipation	400mW
Package thermal resistance (θ _{JA})	SOT23-5 220°C / W
Storage temperature(T _S)	-40°C -150°C
Lead temperature & time	260°C,10S

Note: Exceed these limits to damage to the device. Exposure to absolute maximum rating conditions may affect device reliability.

RECOMMENDED WORK CONDITIONS

Parameter	Value
Input voltage range	2V to 6V
Ambient temperature	-40°C –85°C

ELECTRICAL CHARACTERISTICS

(Test Conditions: C_{IN}=1uF, C_{OUT}=1uF, T_A=25 °C, unless otherwise stated.)

Symbol	Parameter	Conditions	Min	Typ	Max	Units
V _{IN}	Input voltage		2		6	V
V _{FB}	Regulated feedback voltage	V _{IN} =3.3V, I _{OUT} =10mA	0.784	0.8	0.816	V
V _{DROP}	Dropout voltage ⁽¹⁾	V _{OUT} =1.2V, I _{OUT} =300mA		600	800	mV
		V _{OUT} =1.8V, I _{OUT} =300mA		310	400	mV
		V _{OUT} =3.3V, I _{OUT} =300mA		170	220	mV
$\frac{\Delta V_{out}}{\Delta V_{in} \cdot V_{out}}$	Line regulation	I _{OUT} =10mA, 2.5V≤V _{IN} ≤6V		0.05	0.2	%/V
ΔV _{out}	Load regulation	V _{IN} =4.3V, V _{OUT} =3.3V 10mA≤I _{OUT} ≤300mA		10	30	mV
I _Q	Supply current	V _{IN} = V _{OUT} +1V, V _{IN} = V _{EN}		65	100	uA
I _{STANDBY}	Supply current (standby)	V _{IN} = V _{OUT} +1V, V _{EN} =GND		0.1	1.0	uA
$\frac{\Delta V_{out}}{\Delta T \cdot V_{out}}$	Output voltage temperature coefficient	I _{OUT} =10mA		±100		ppm/°C
PSRR	Ripple rejection	F=1KHz, Ripple=1Vp-p V _{IN} = V _{OUT} +1V		65		dB
I _{LIM}	Current limit	V _{IN} =4.3V, V _{OUT} =3.3V	300			mA
I _{SHORT}	Short current limit	V _{OUT} =0V		200		mA
R _{DISCHARGE}	Discharge resistor	EN=0, V _{OUT} =3V		2K		Ω
V _{ENH}	EN input voltage “H”		1.5		V _{IN}	V
V _{ENL}	EN input Voltage “L”		0		0.3	V
T _{SD}	Thermal shutdown temp			160		°C
T _{SH}	Thermal shutdown hysteresis			30		°C

Note: 1) V_{DROP}= V_{IN}- V_{OUT} when V_{OUT} drops below 98% of the normal V_{OUT}.

PIN DESCRIPTION

Pin #	Name	Description
1	VIN	Supply Voltage Input. Supply voltage can range from 2V to 6V.
2	GND	Ground Pin
3	EN	Enable Pin. This pin has an internal pull-down resistor. A logic low reduces the supply current to less than 1 μ A. Connect to IN for normal operation.
4	FB	Feedback Pin. This is used to set the output voltage of the device.
5	VOUT	Output Voltage

BLOCK DIAGRAM

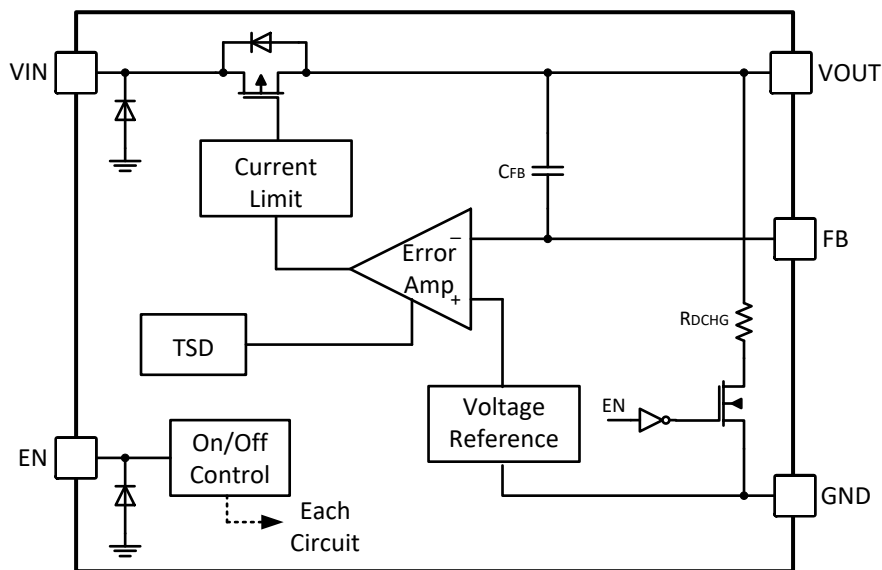

EXPLANATION

BL8079G series is a group of positive voltage output, low noise, low power consumption, low dropout voltage regulator.

BL8079G can provide output value adjustable from 0.8V to 5.0V.

BL8079G includes high accuracy voltage reference, error amplifier, current limit circuit and output driver module.

BL8079G has excellent load and line transient response and good temperature characteristics, which can assure the stability of chip and power system. It uses trimming technique to guarantee output voltage accuracy within $\pm 2\%$. And it also provides fold-back short-circuit protection, thermal protection and output current limit function.

TYPICAL PERFORMANCE CHARACTERISTICS

Load Regulation
(Vout=1.2V)

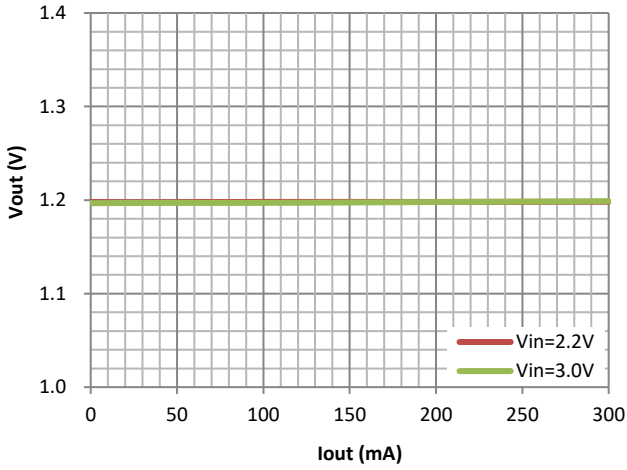

Load Regulation
(Vout=1.8V)

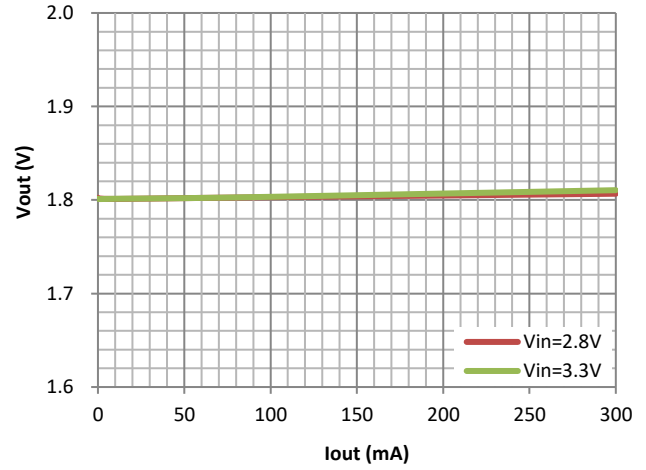

Load Regulation
(Vout=3.3V)

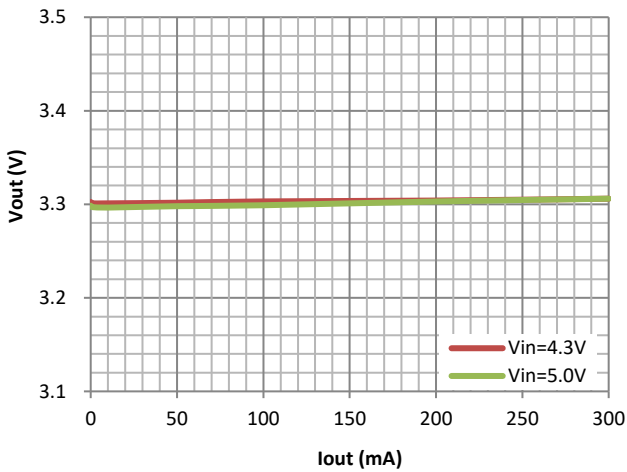

Line Regulation
(Vout=1.2V)

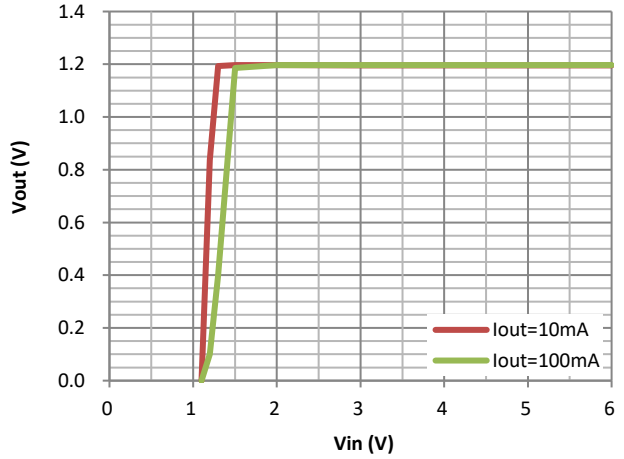

Dropout Voltage

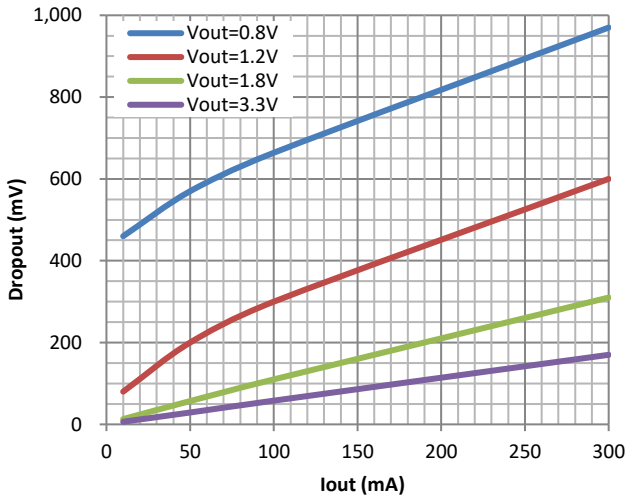

Iq

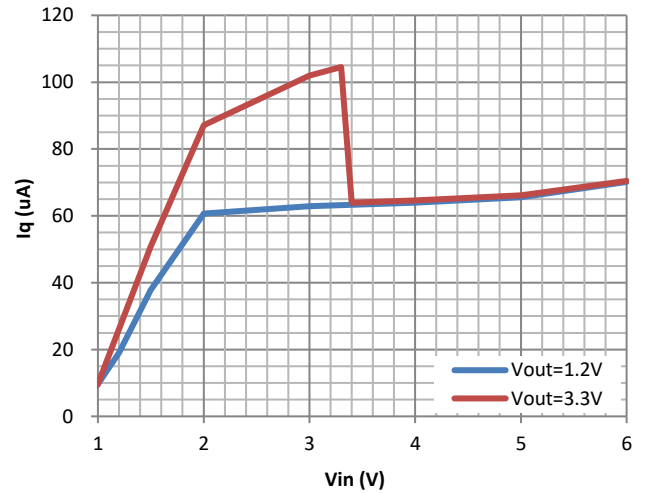

Current limit

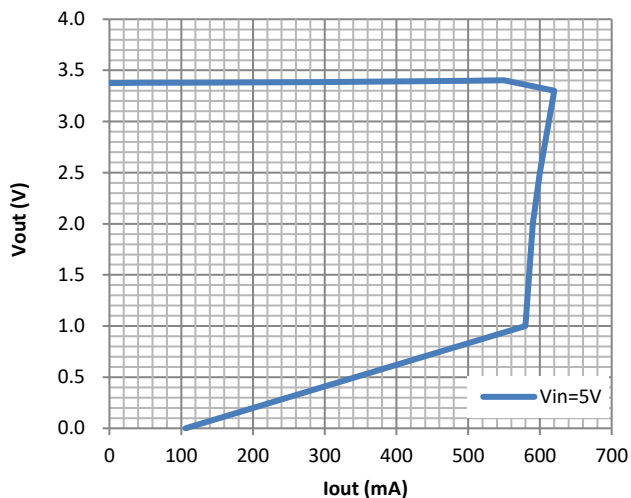

PSRR (Iout=10mA)

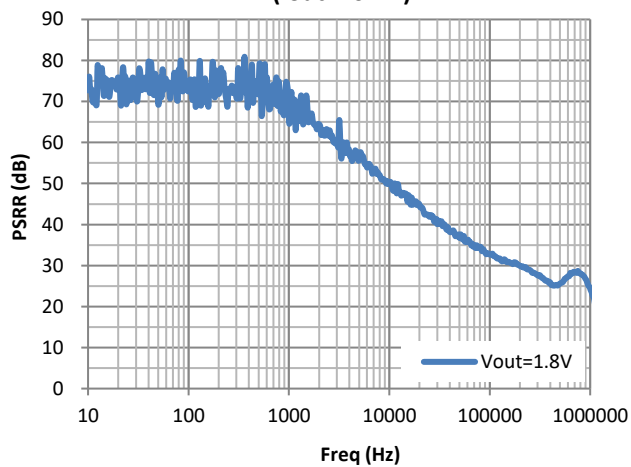

EN Chip Enable Response

(EN=0V to 3V, Vin=5V, Vout=1.2V, Iout=10mA)

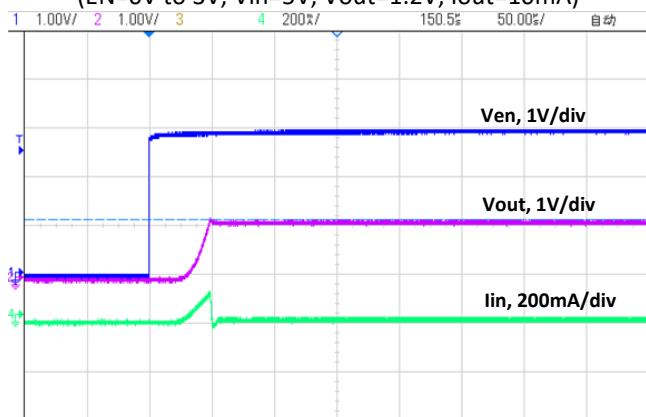

CH1: EN; CH2: Vout; CH4: Iin

EN Chip Enable Response

(EN=3V to 0V, Vin=5V, Vout=1.2V, Iout=10mA)

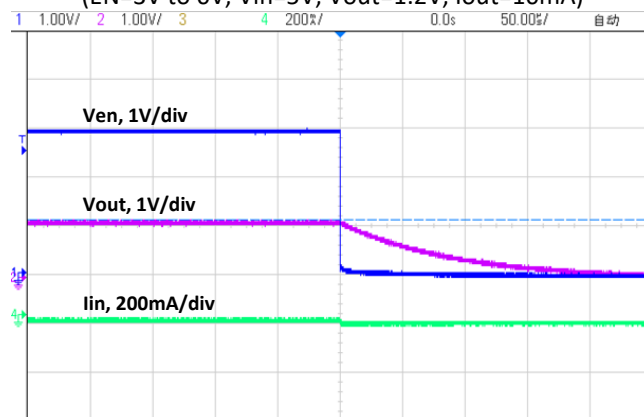

CH1: EN; CH2: Vout; CH4: Iin

PACKAGE OUTLINE

Package	SOT-23-5	Devices per reel	3000pcs																																																																							
Package dimension:																																																																										
		<table border="1"> <thead> <tr> <th rowspan="2">SYMBOL</th> <th colspan="3">MILLIMETER</th> </tr> <tr> <th>MIN</th> <th>NOM</th> <th>MAX</th> </tr> </thead> <tbody> <tr> <td>A</td> <td>—</td> <td>—</td> <td>1.25</td> </tr> <tr> <td>A1</td> <td>0.04</td> <td>—</td> <td>0.10</td> </tr> <tr> <td>A2</td> <td>1.00</td> <td>1.10</td> <td>1.20</td> </tr> <tr> <td>A3</td> <td>0.60</td> <td>0.65</td> <td>0.70</td> </tr> <tr> <td>b</td> <td>0.33</td> <td>—</td> <td>0.41</td> </tr> <tr> <td>b1</td> <td>0.32</td> <td>0.35</td> <td>0.38</td> </tr> <tr> <td>c</td> <td>0.15</td> <td>—</td> <td>0.19</td> </tr> <tr> <td>c1</td> <td>0.14</td> <td>0.15</td> <td>0.16</td> </tr> <tr> <td>D</td> <td>2.82</td> <td>2.92</td> <td>3.02</td> </tr> <tr> <td>E</td> <td>2.60</td> <td>2.80</td> <td>3.00</td> </tr> <tr> <td>E1</td> <td>1.50</td> <td>1.60</td> <td>1.70</td> </tr> <tr> <td>e</td> <td colspan="3">0.95BSC</td> </tr> <tr> <td>e1</td> <td colspan="3">1.90BSC</td> </tr> <tr> <td>L</td> <td>0.30</td> <td>—</td> <td>0.60</td> </tr> <tr> <td>L1</td> <td colspan="3">0.60REF</td> </tr> <tr> <td>θ</td> <td>0</td> <td>—</td> <td>8°</td> </tr> </tbody> </table>		SYMBOL	MILLIMETER			MIN	NOM	MAX	A	—	—	1.25	A1	0.04	—	0.10	A2	1.00	1.10	1.20	A3	0.60	0.65	0.70	b	0.33	—	0.41	b1	0.32	0.35	0.38	c	0.15	—	0.19	c1	0.14	0.15	0.16	D	2.82	2.92	3.02	E	2.60	2.80	3.00	E1	1.50	1.60	1.70	e	0.95BSC			e1	1.90BSC			L	0.30	—	0.60	L1	0.60REF			θ	0	—	8°
SYMBOL	MILLIMETER																																																																									
	MIN	NOM	MAX																																																																							
A	—	—	1.25																																																																							
A1	0.04	—	0.10																																																																							
A2	1.00	1.10	1.20																																																																							
A3	0.60	0.65	0.70																																																																							
b	0.33	—	0.41																																																																							
b1	0.32	0.35	0.38																																																																							
c	0.15	—	0.19																																																																							
c1	0.14	0.15	0.16																																																																							
D	2.82	2.92	3.02																																																																							
E	2.60	2.80	3.00																																																																							
E1	1.50	1.60	1.70																																																																							
e	0.95BSC																																																																									
e1	1.90BSC																																																																									
L	0.30	—	0.60																																																																							
L1	0.60REF																																																																									
θ	0	—	8°																																																																							
Unit: mm																																																																										

Package	SOT-23-5	Devices per reel	3000pcs
Package dimension:			
Unit: mm			

深圳市泰德兰电子有限公司（简称：泰德兰），是一家专业代理国内外品牌电子元器件代理商。“泰德兰”的目标是为客户提供高性价比的产品和服务。我们一贯坚持：“品质第一、价格合理、交货快捷、服务至上、凝聚客户”的发展理念和宗旨以向采购商提供最满意的服务为己任，向采购商提供规范化、专业化、多元化、全方位的优质服务，真诚欢迎海内外直接用户前来洽谈合作，共谋发展！也希望能与电子界同行进行广泛的交流合作共同为行业的繁荣发展做出贡献！

目前，泰德兰电子主要代理：霍尼韦尔、理光、NJRC、英集芯、维安、贝岭、捷捷微、冠禹、松木、辉芒微、茂捷等。

主营产品线有 LDO、DC/DC、AC-DC、电压检测器、充电 IC、负载开关 IC、保险丝、多功能集成保护 IC、功率 TVS 管、二三极管、PMU、马达驱动、LED 驱动、功率器件、数字电源、Hall IC、磁组、传感器 IC、汽容胶传感器、压力传感器、位移传感器、惯导模块、锂电保护芯片、微动开关、IGBT、PTC、ESD、EEPROM, 8bit/32bit MCU, PMIC、中低压 MOS 管、高压 COOL MOS、高压平面 MOSFET 等。

“泰德兰”代理的产品被广泛应用于液晶电视、笔记本、联网、便携式设备、机顶盒、闭路电视/安全、桌面、LED 照明、玩具、网络电视机、无人机、扫地机、无线充、蓝牙设备、汽车应用、行车记录仪、无线路由等领域。

“泰德兰”所代理的产品均通过 ISO 9001:2000 品质管理系统检验；获得原厂颁发的代理授权证书。

深圳公司

深圳市泰德兰电子有限公司

地址：深圳市福田区彩田南路 2010 号中深花园 A 座六层

电话：0755-83322522 传真：0755-83648400

手机：131-89714166 Q Q：2853781768